

MICRO END EFFECTORS

MEE

MARS MISSION

(Detect Life on MARS)

SURFACE SAMPLING

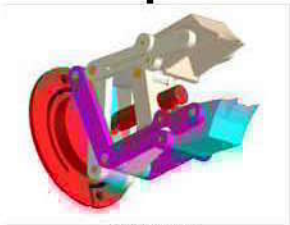

SSADT I
(for ESA)



SSADT II
(for ESA)



OVERLAPPING 3 JAWS



MANTA
(for Daimler Benz)



MANTA
(for Daimler Benz)

SURFACE CORING



ROCK CORER
(for ESA)



RIND COLLECTOR
(for Max Planck)



ULTRASONIC DRILL
(for JPL/NASA)

SUB-SURFACE SAMPLING

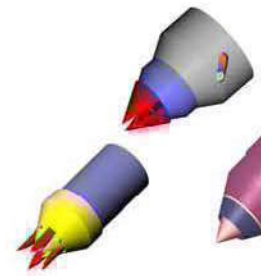

MOLE MEE
(for ESA)

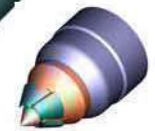

SUPER PEN
(for ESA)



PHOBOS SAMPLE RETURN
(for IKI)



DEPLOYMENT UNIT
(for ESA)

SUB-SURFACE CORING



MOLE CORER
(for Max Planck)



BRILLANT MOLE
(for Shell)



DRILL IN DRILL
(for VTT)

ZERO GRAVITY SAMPLING



MICROSAMPLER
(for Daimler Benz)



MICROS ANCHORAGE GRIPPER
(for Daimler Benz)

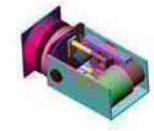

BEAGLE 2 GRINDER I
(for ESA)



NANOKHOD
RIND GRINDER
(for Mainz U)



BEAGLE 2 GRINDER II
(for ESA)

RIND GRINDER

BEAGLE 2

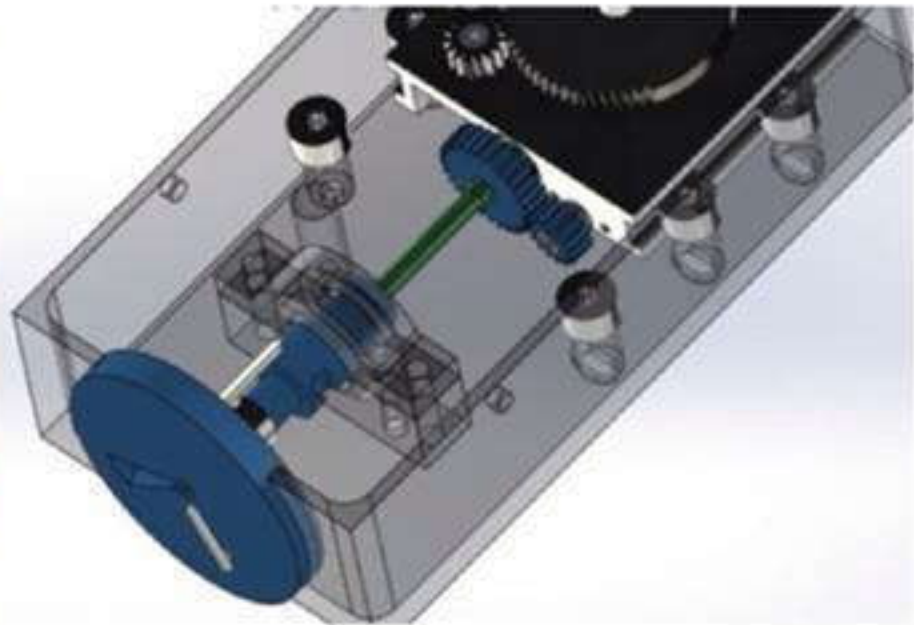
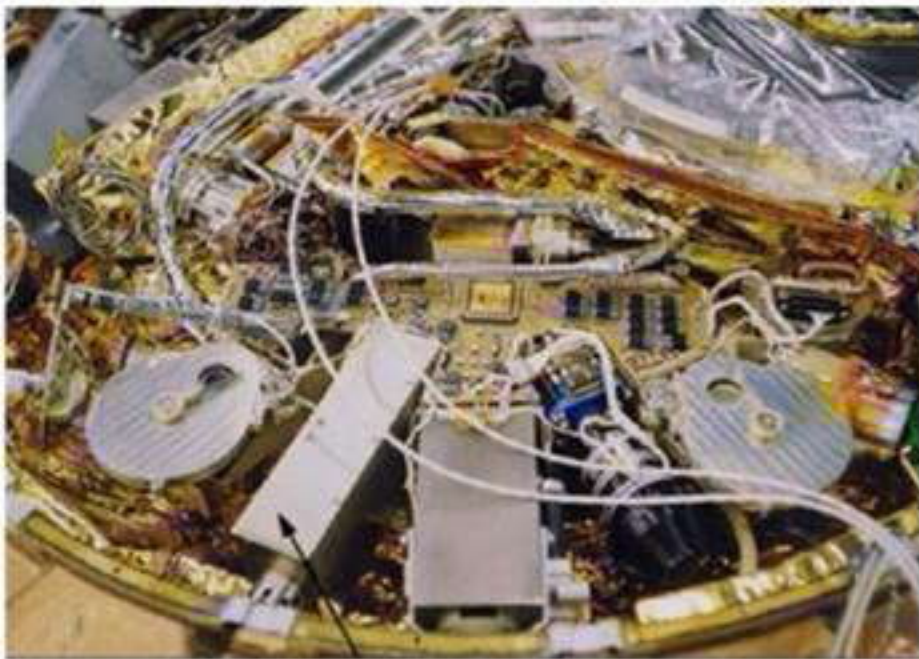
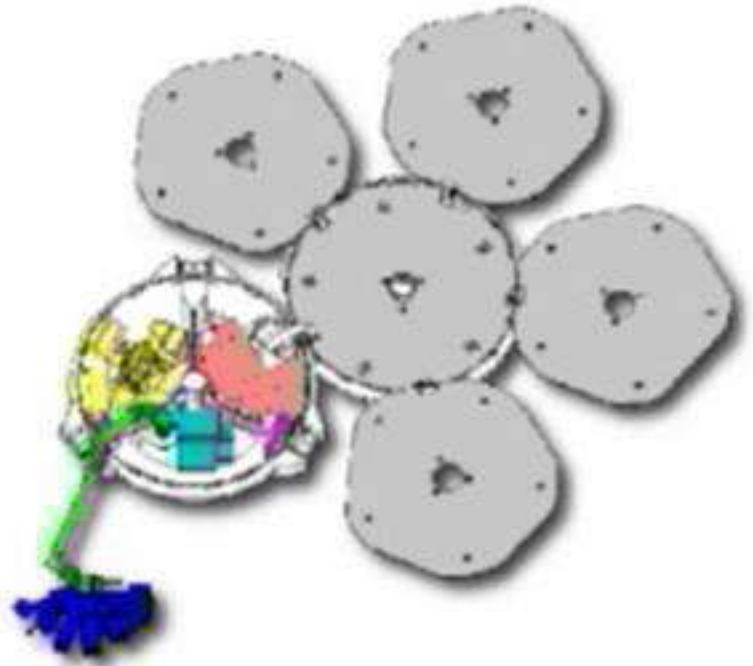

EXOMARS

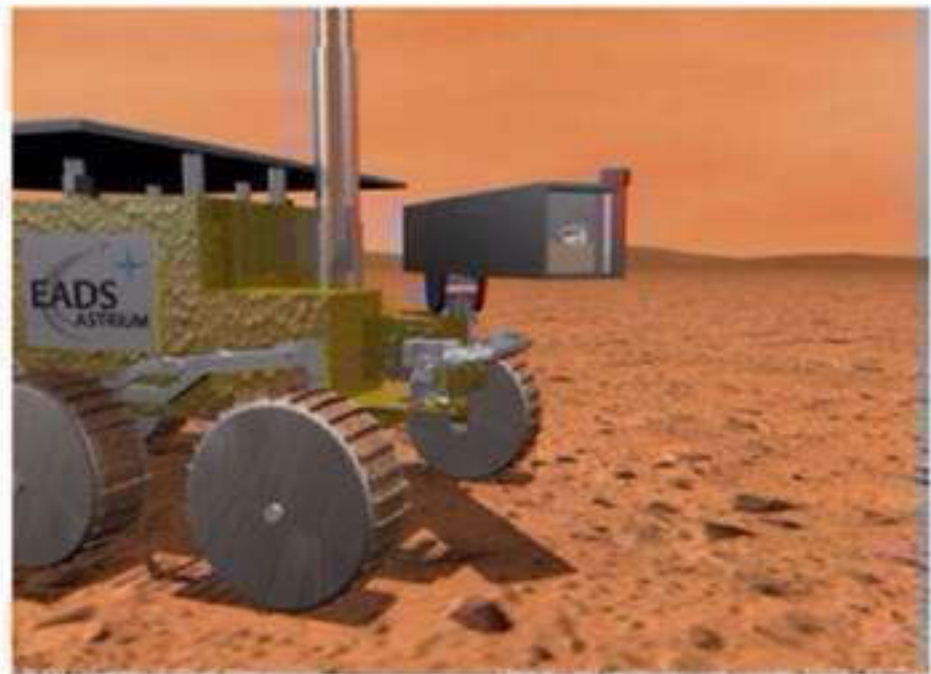
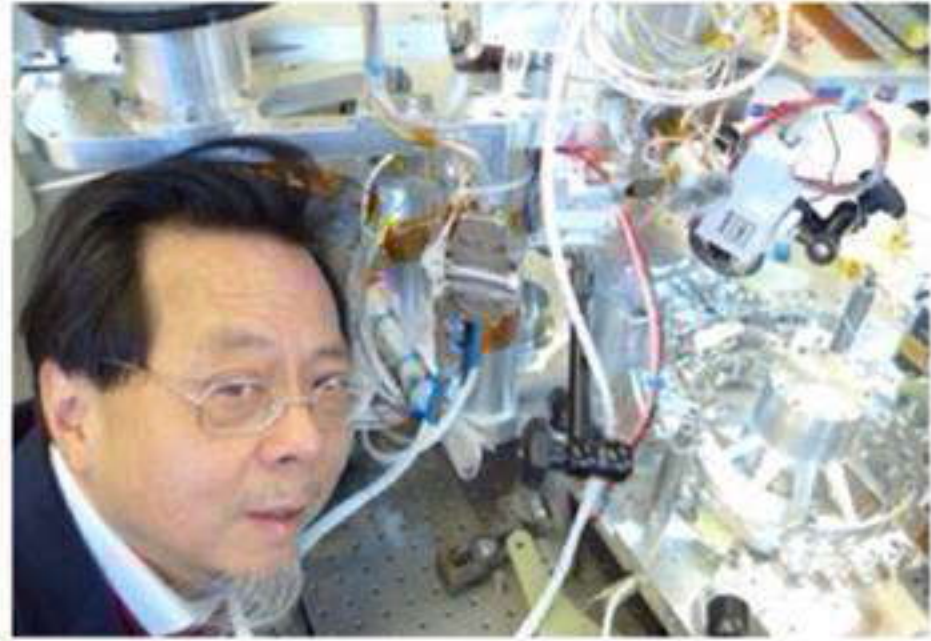

EUROPA SAMPLING

- Lander

1/ from bottom

2/ from leg

3/ from robotic arm

- Penetrator

- Piggy Back

LANDER

0-10 cm EUROPA ICE INVESTIGATIONS

- **BOTTOM OF LANDER**
 - **LEG OF LANDER**
 - **ROBOTIC ARM OF LANDER**
- SUBLIMATION SAMPLES IN ULTRA THIN ICE LAYER FORM
- SOLID ICE SAMPLES

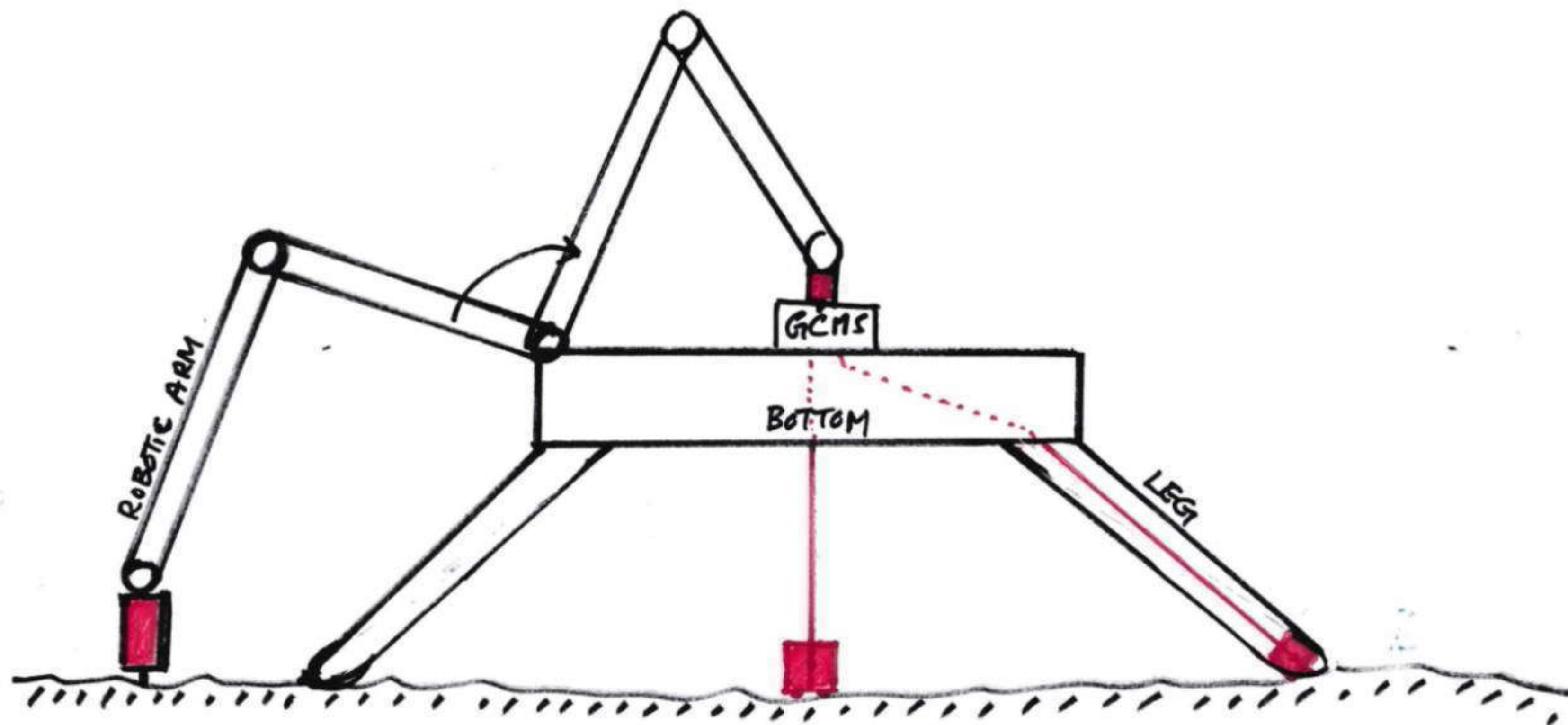

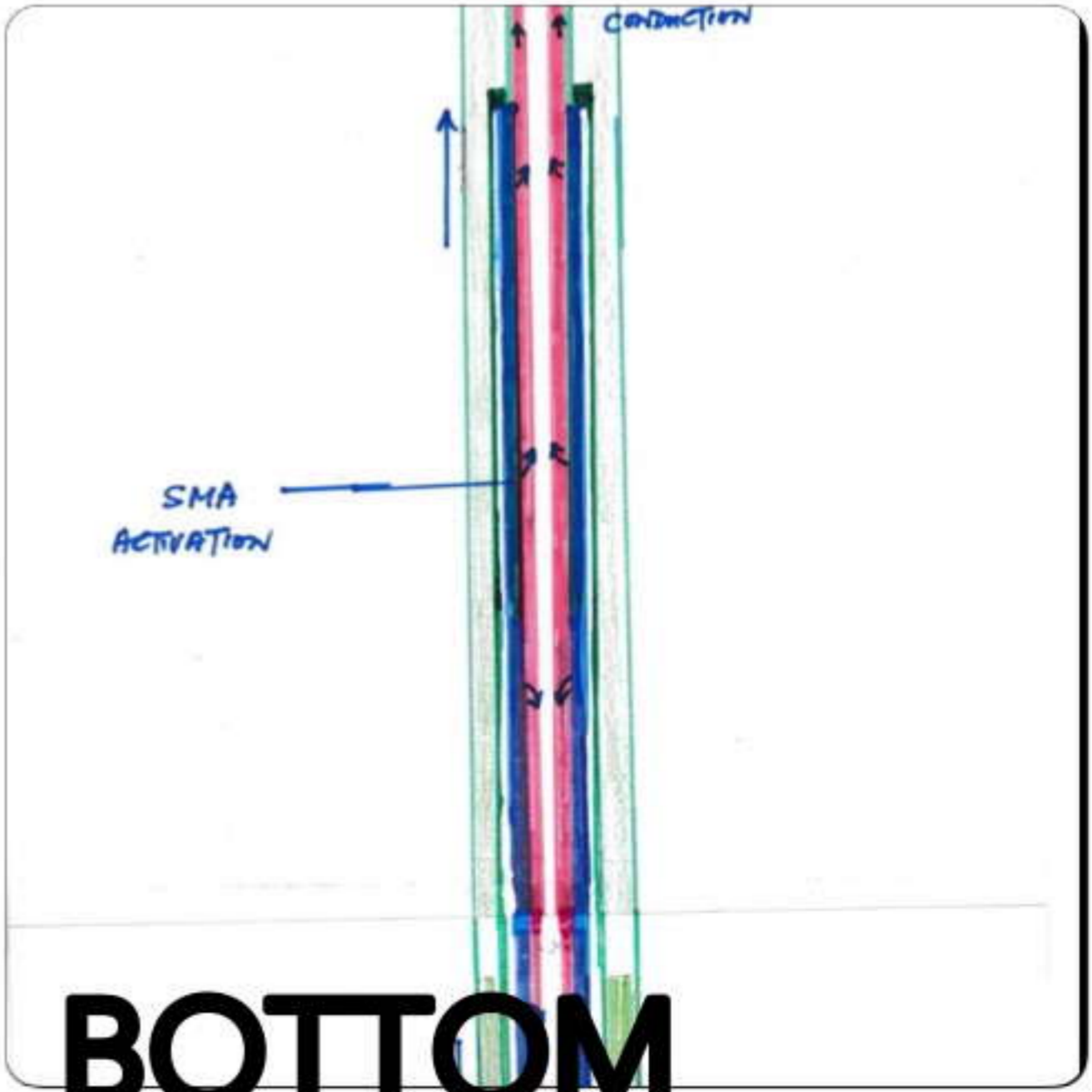
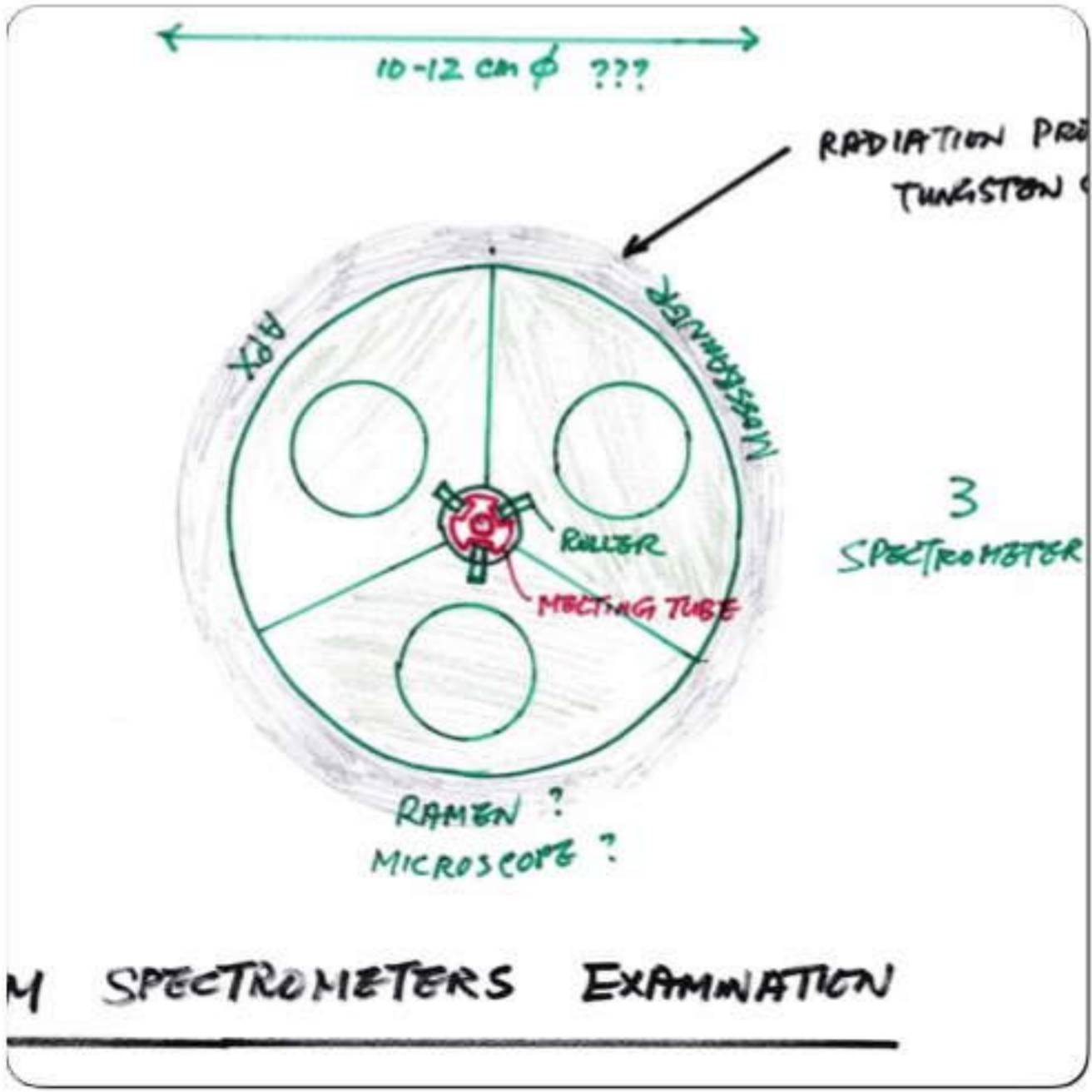
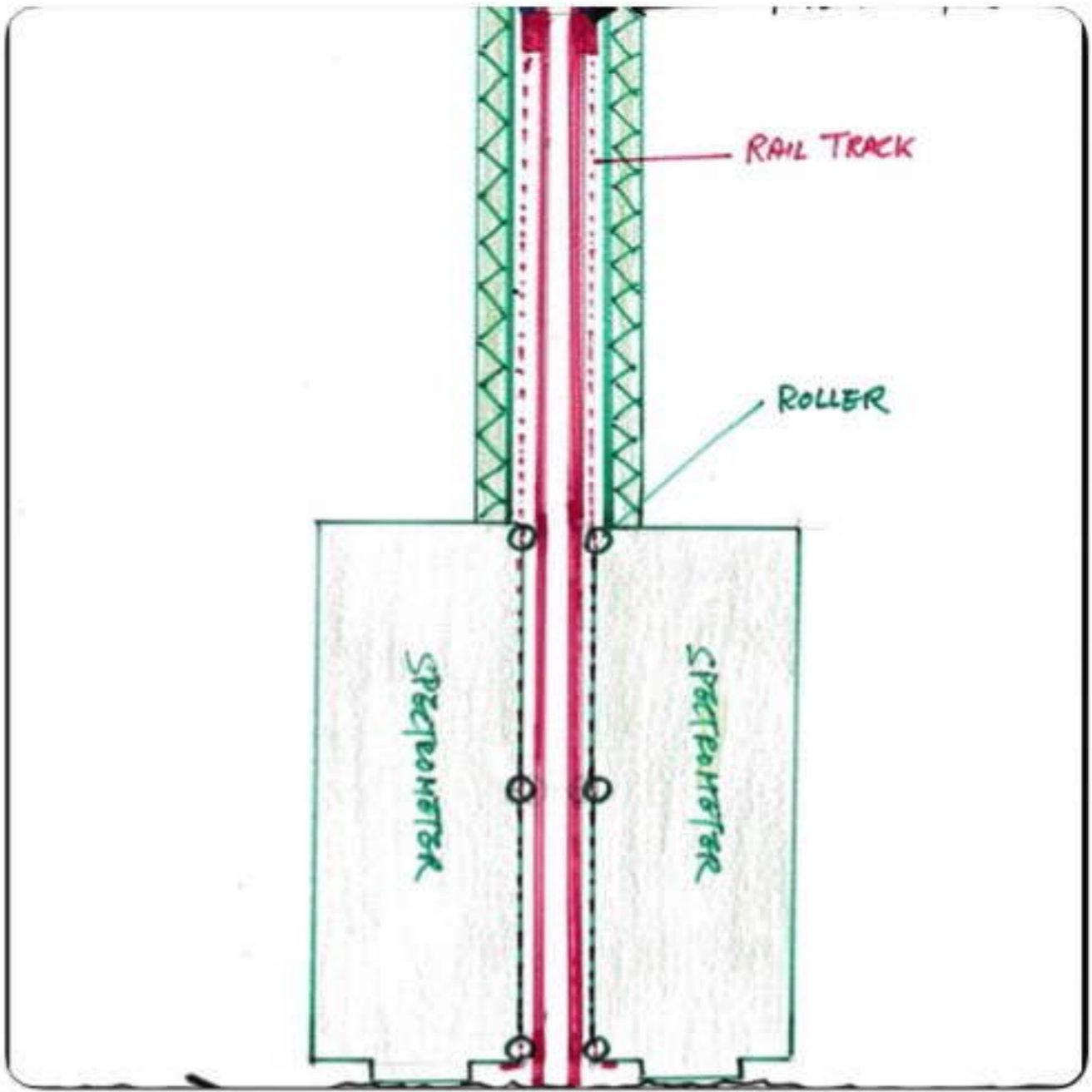
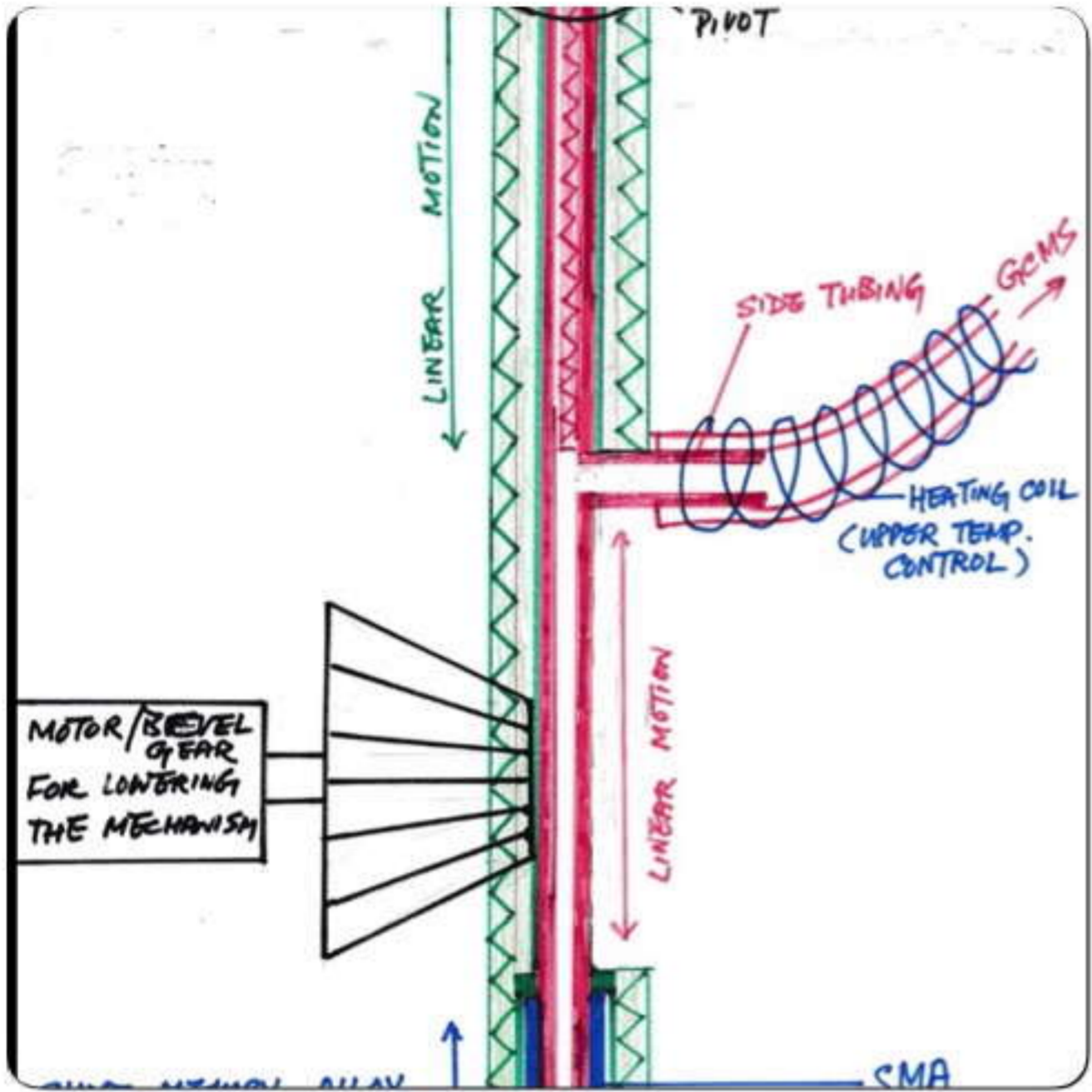

BOTTOM

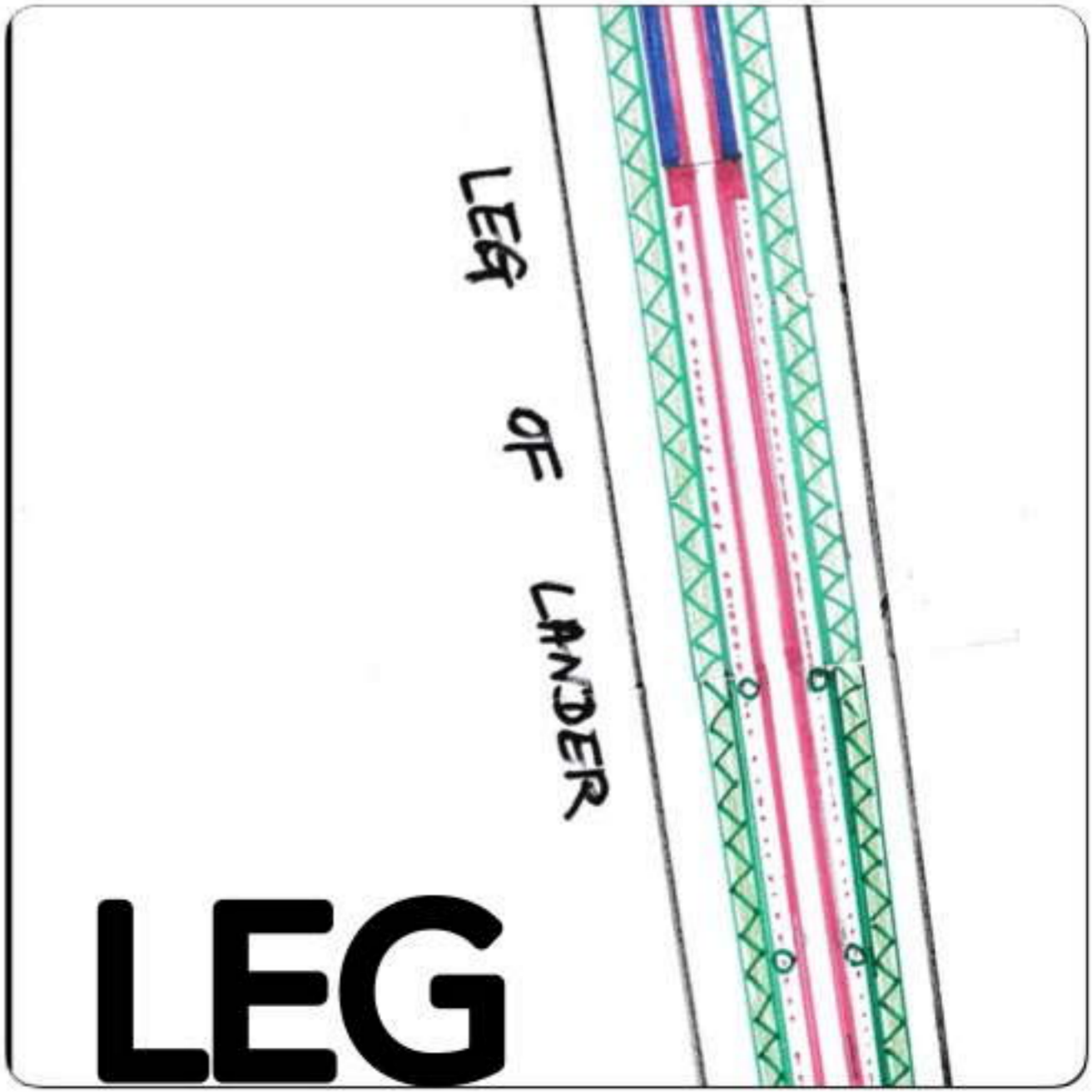
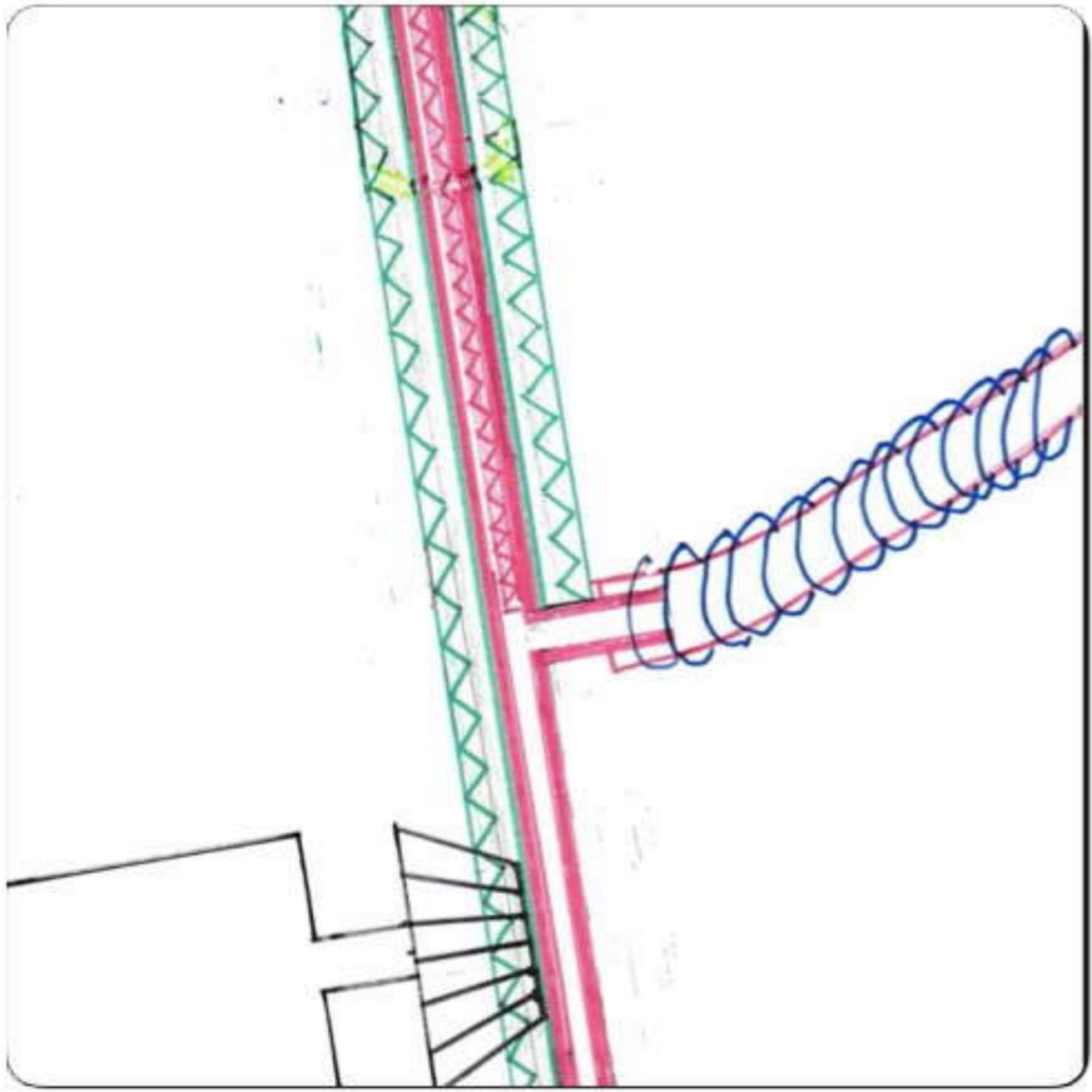
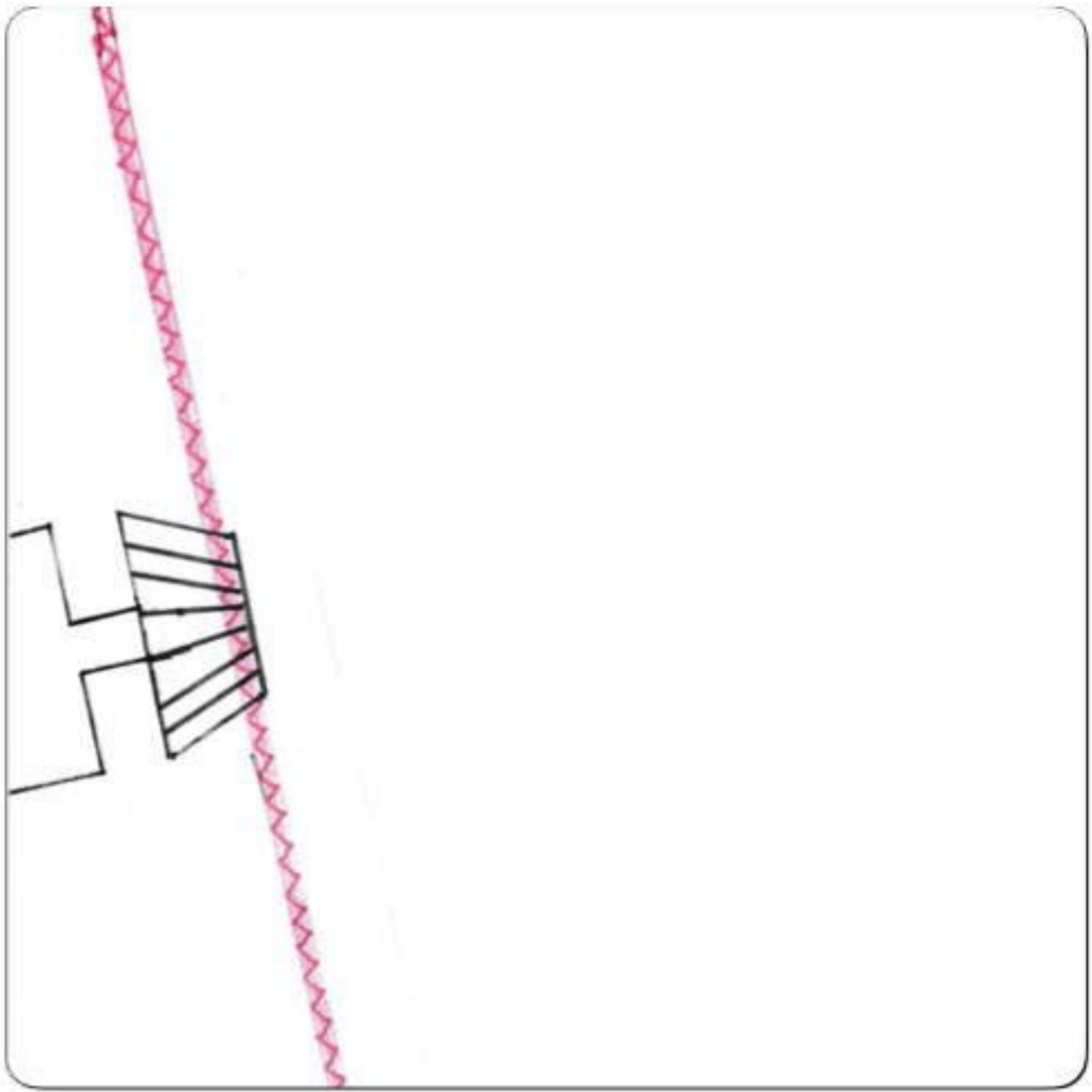
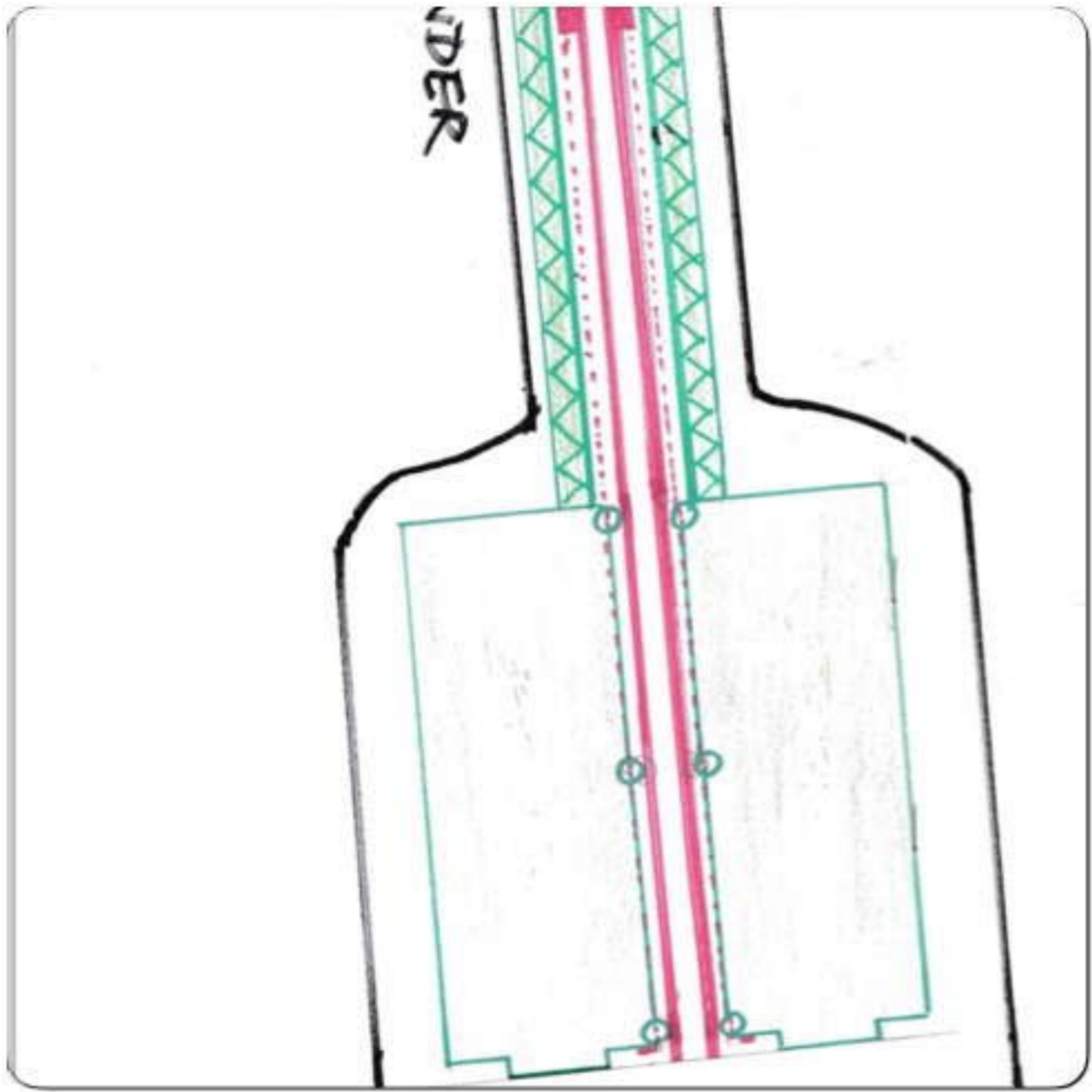

ARM END EFFECTORS

ROBOTIC

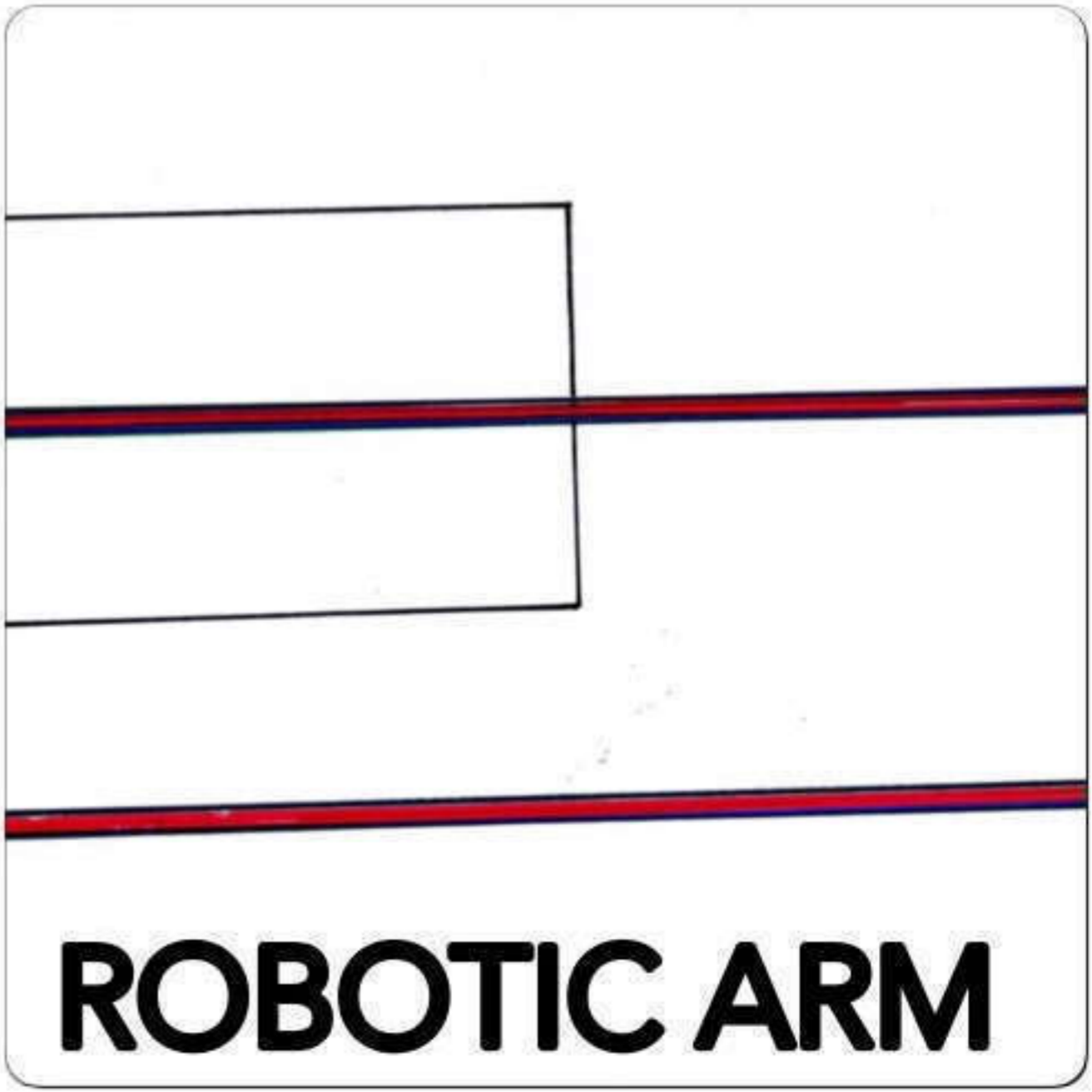
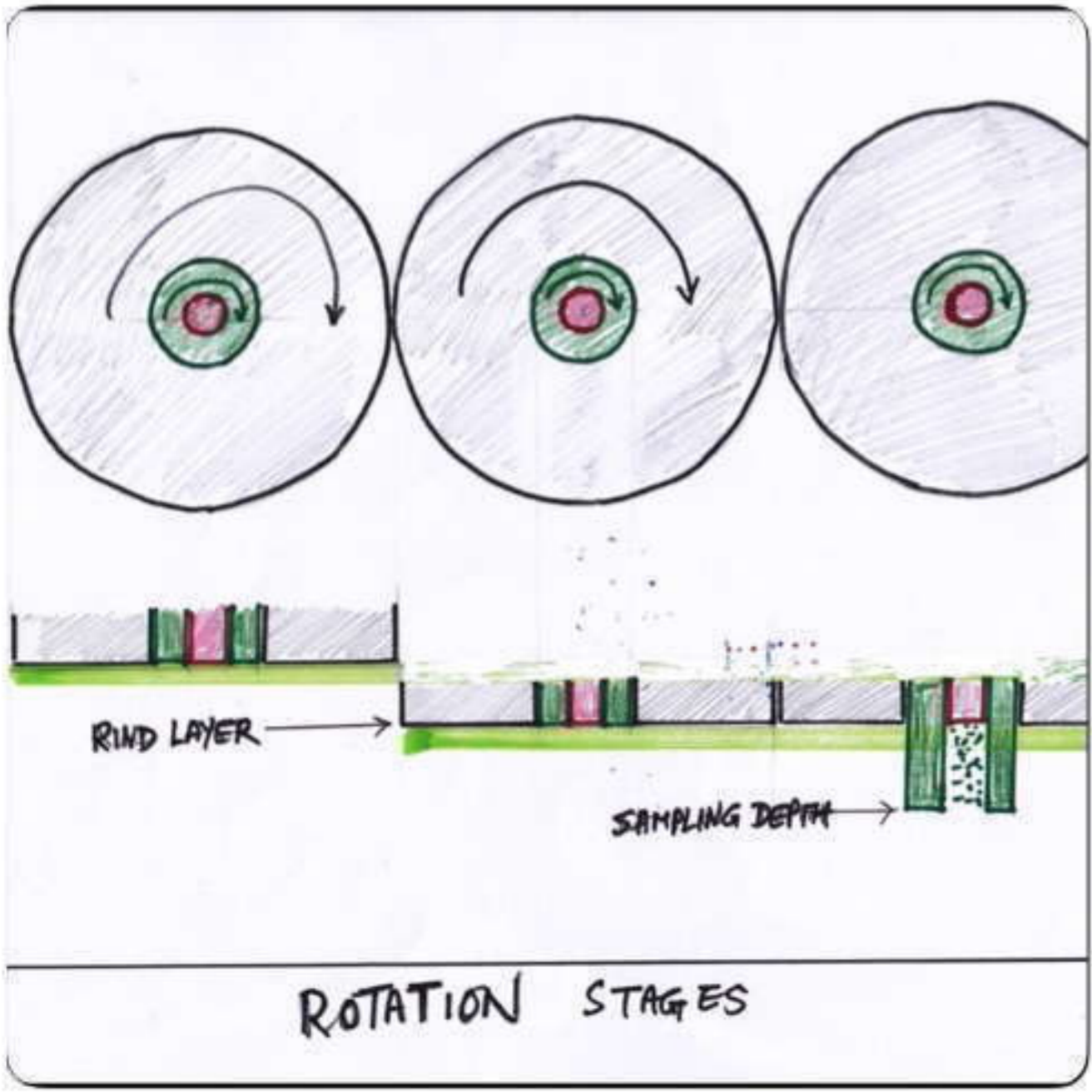
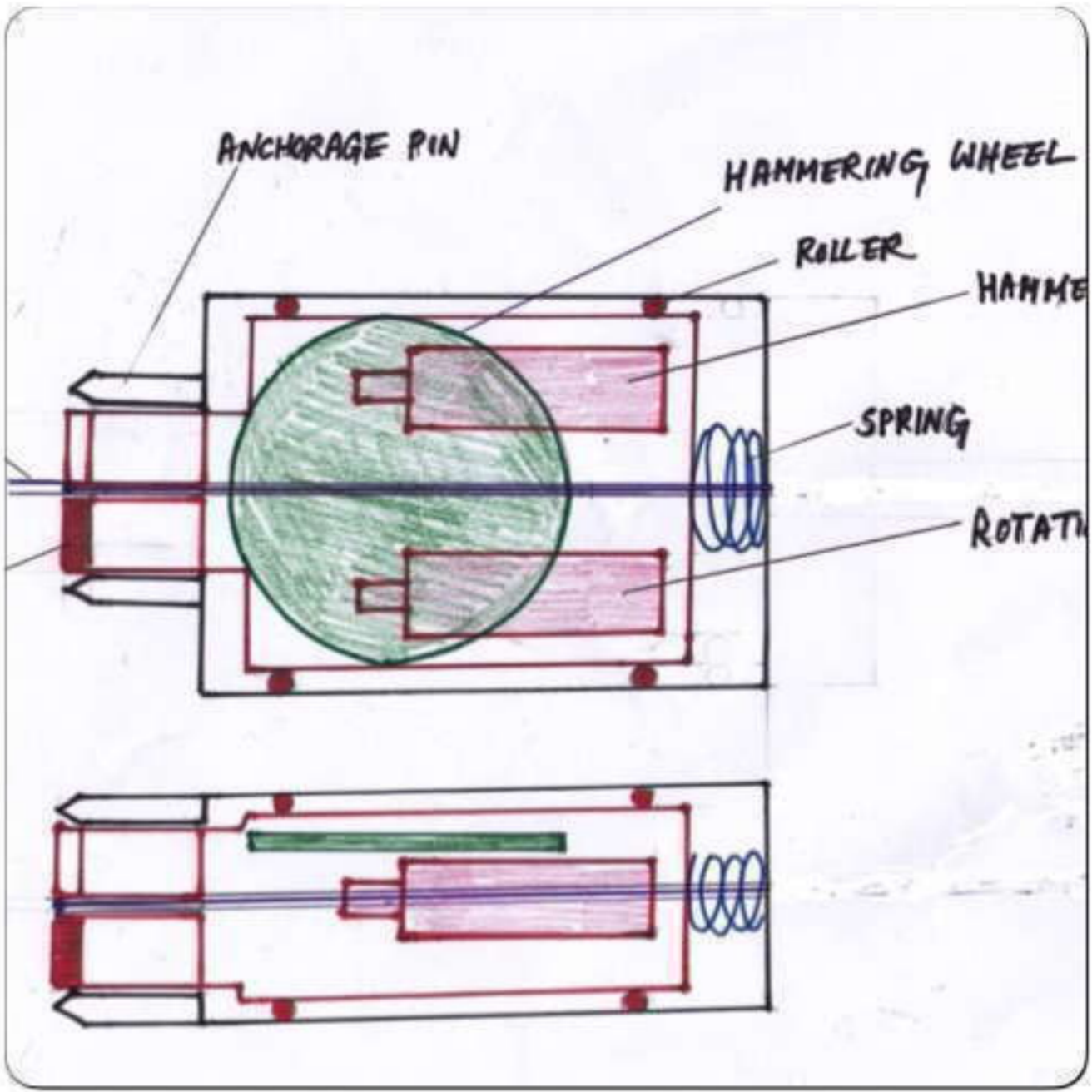
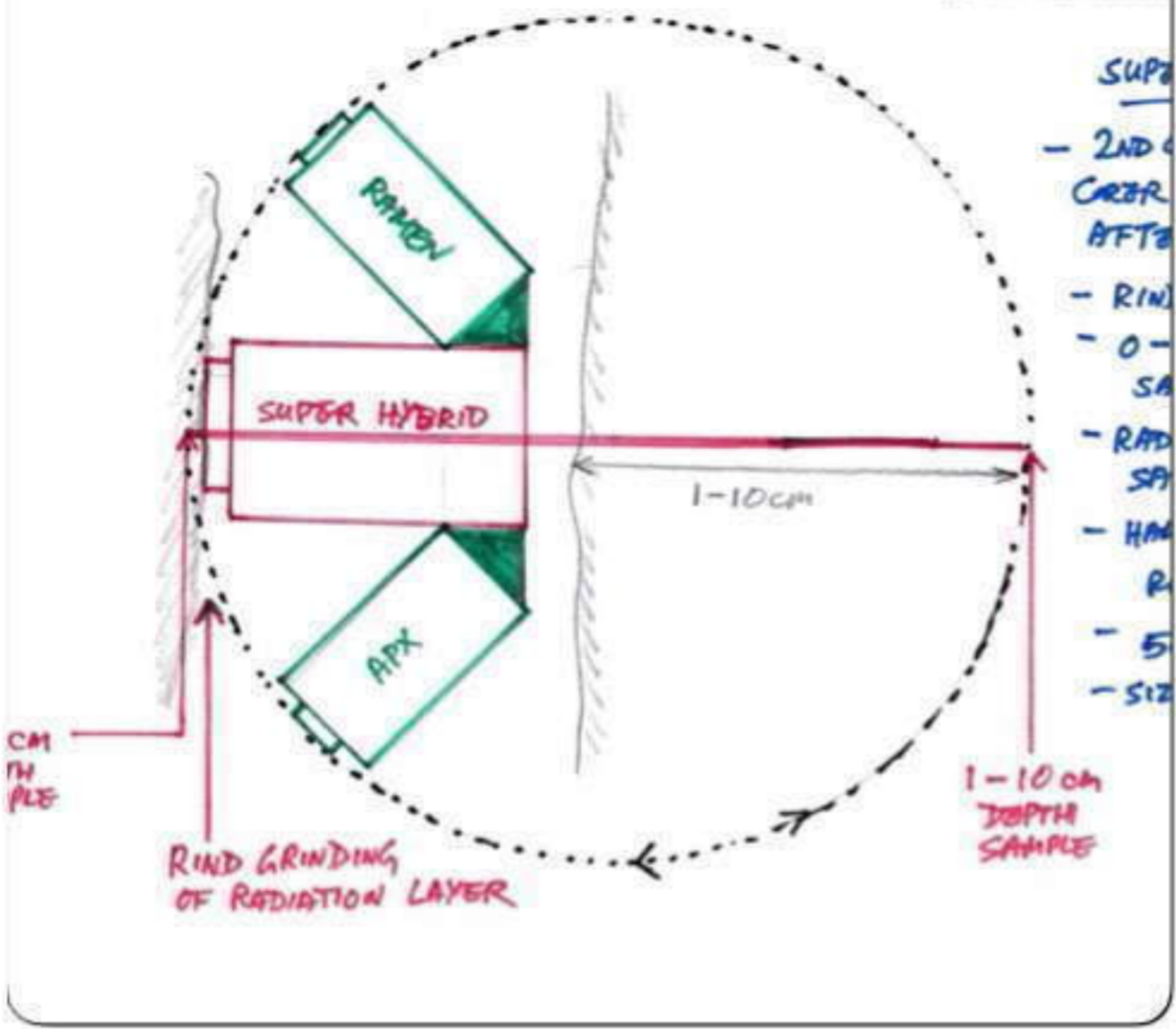

ROBOTIC ARM

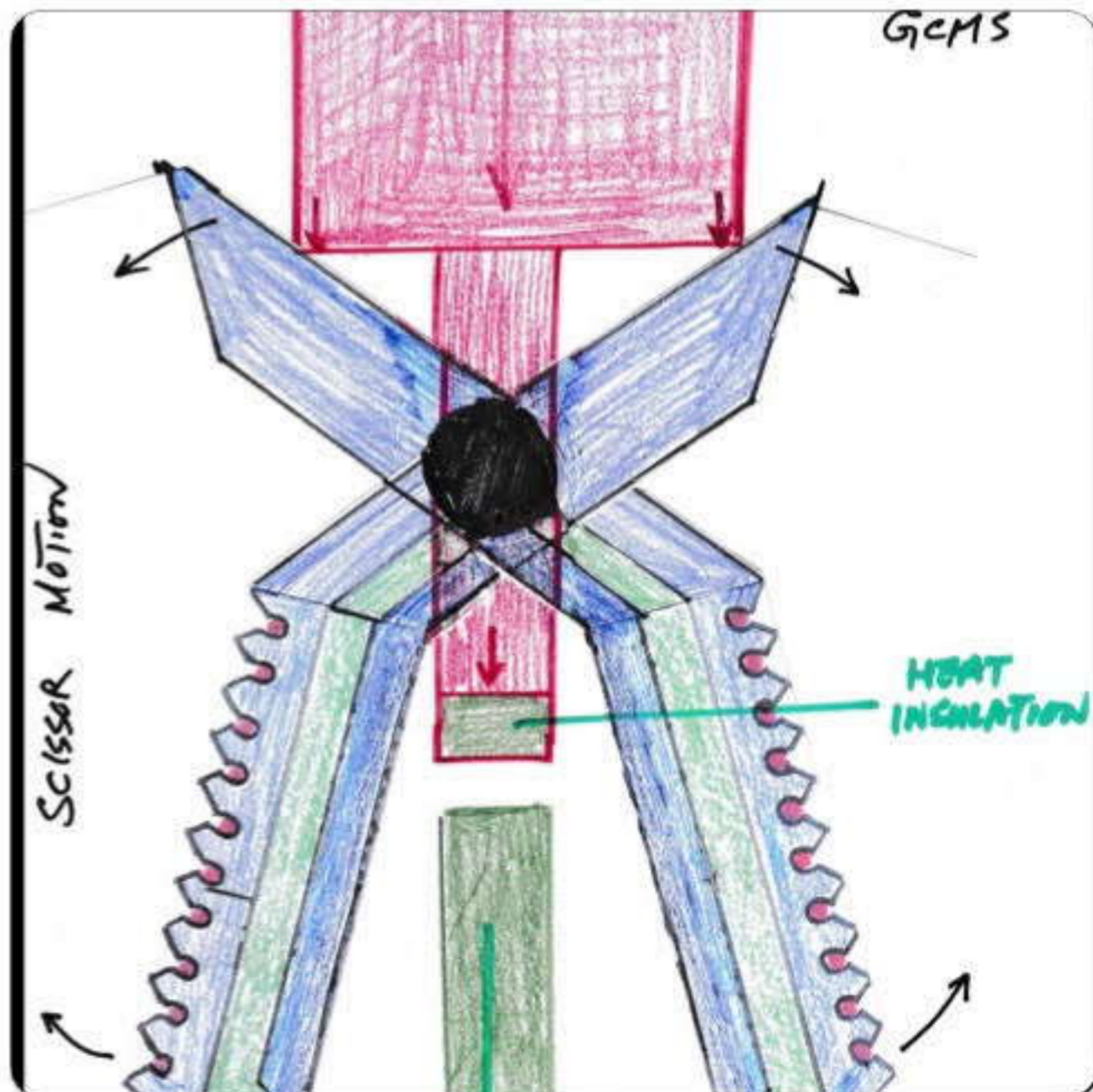
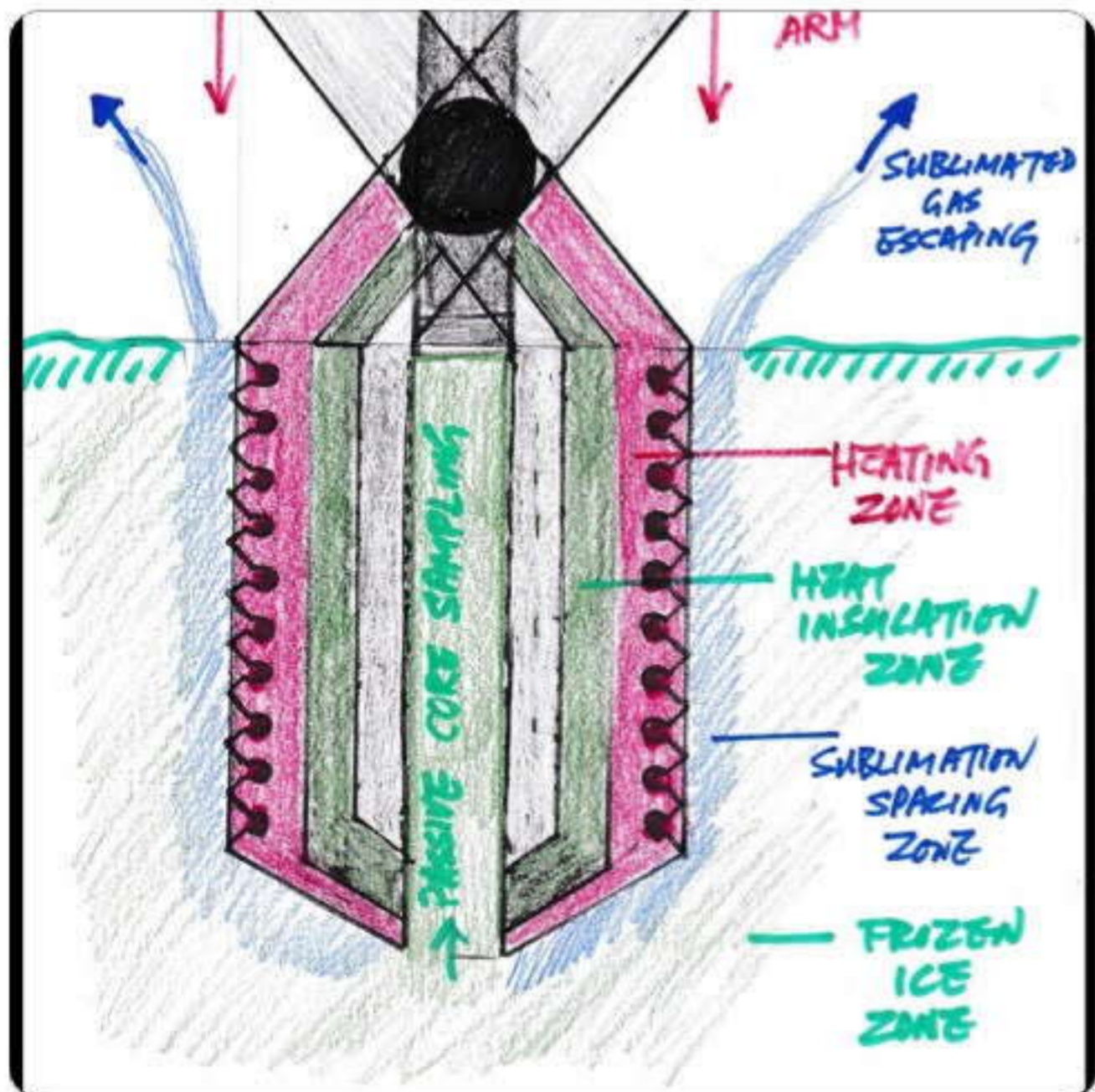
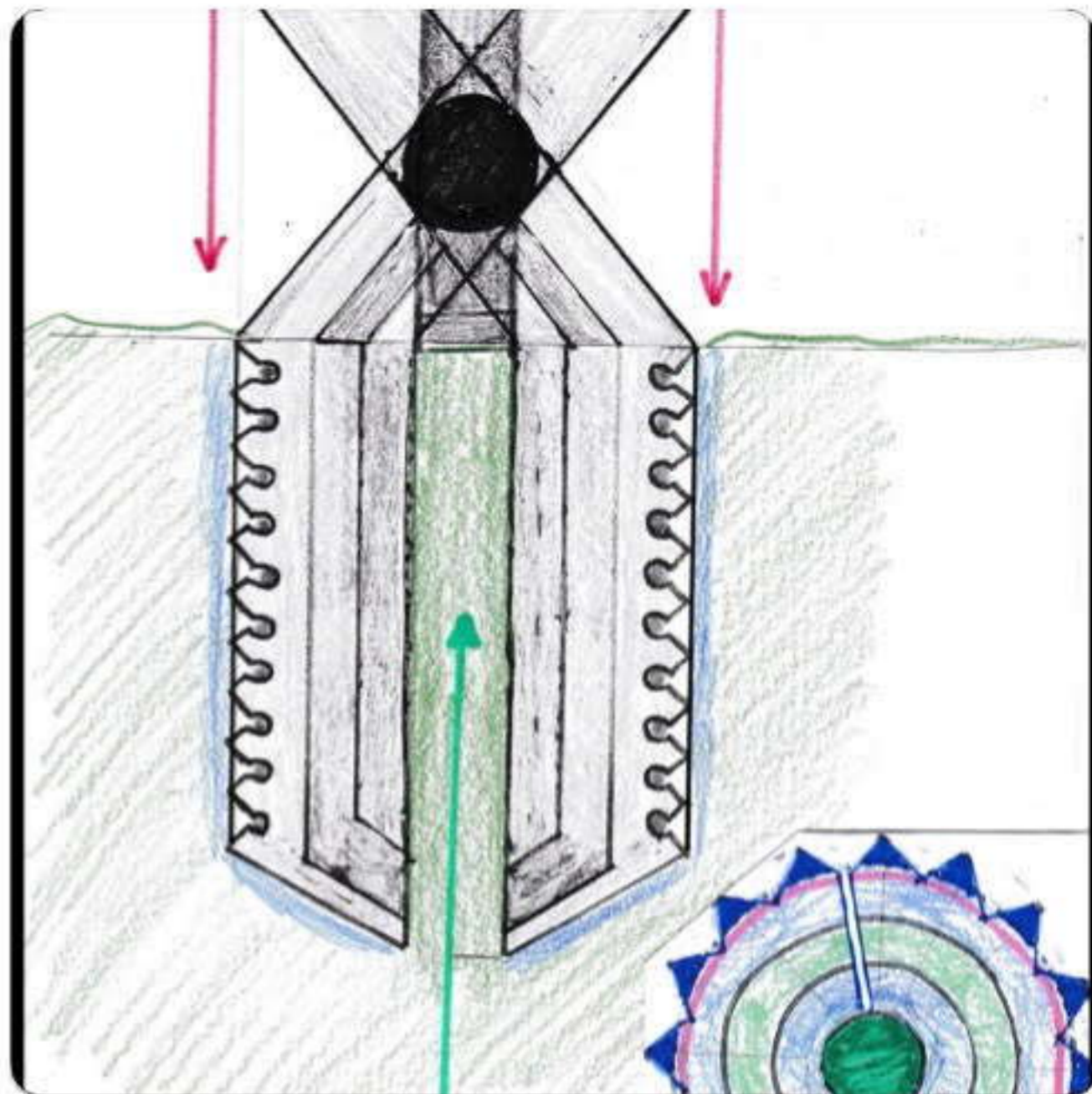
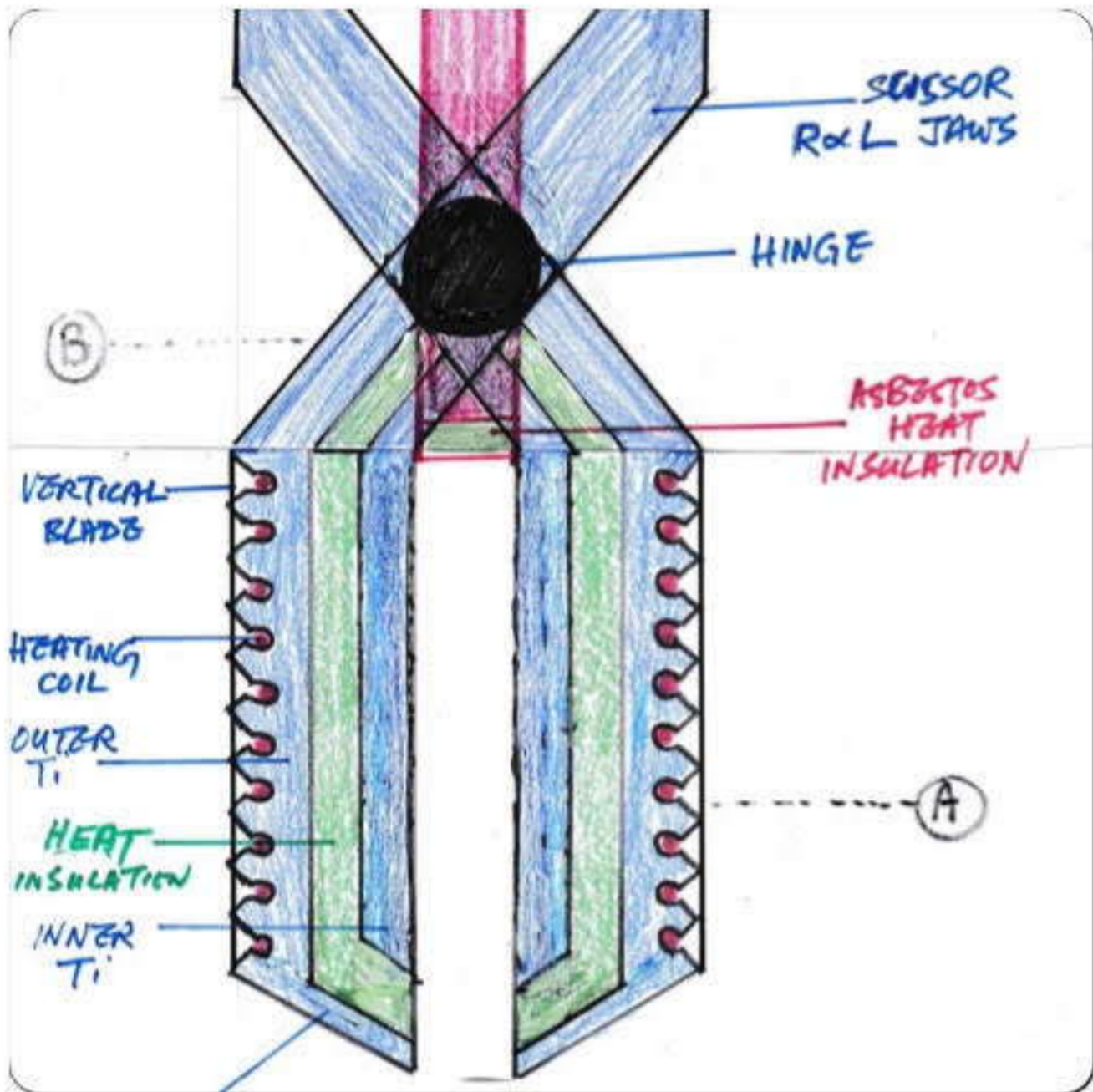

PENETRATOR

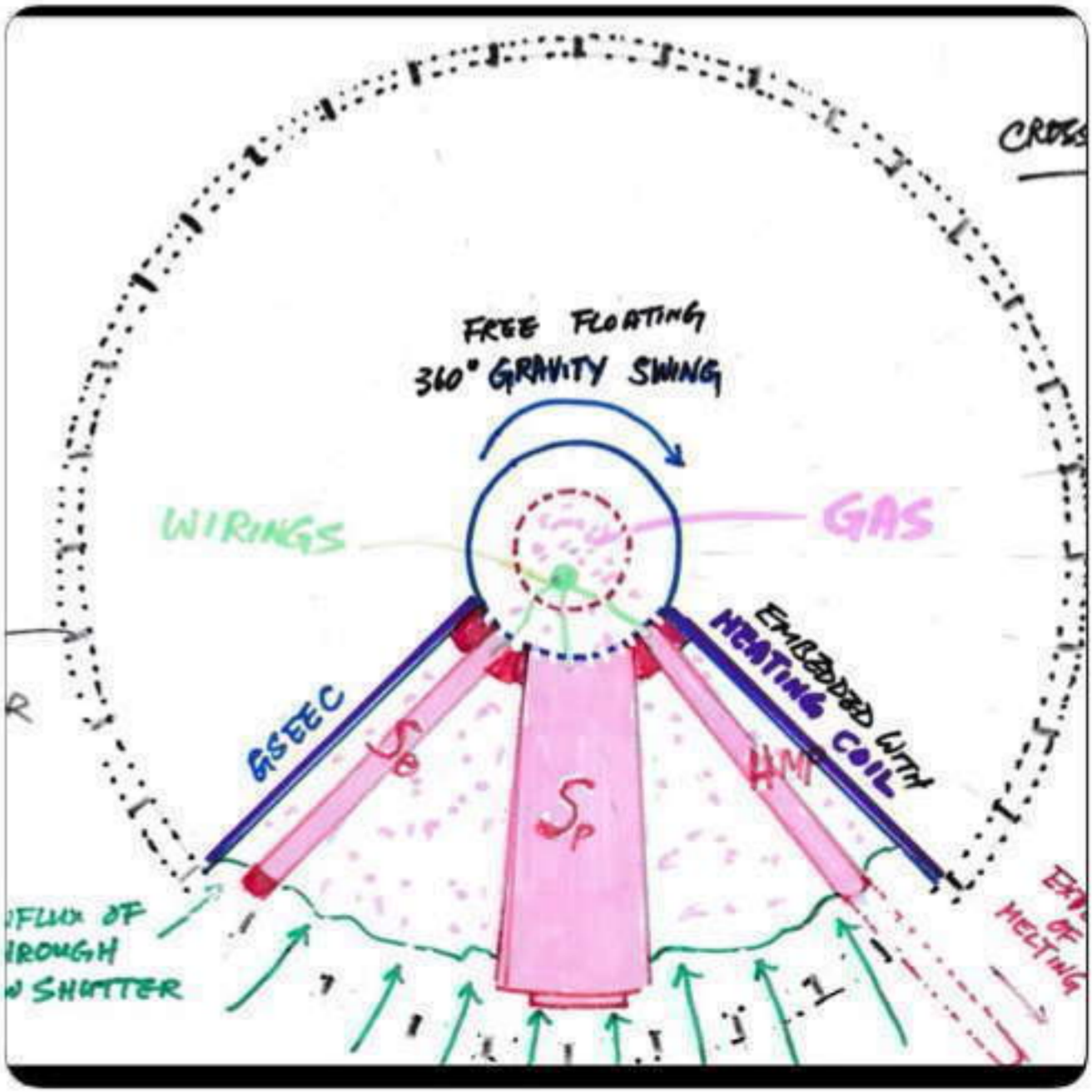
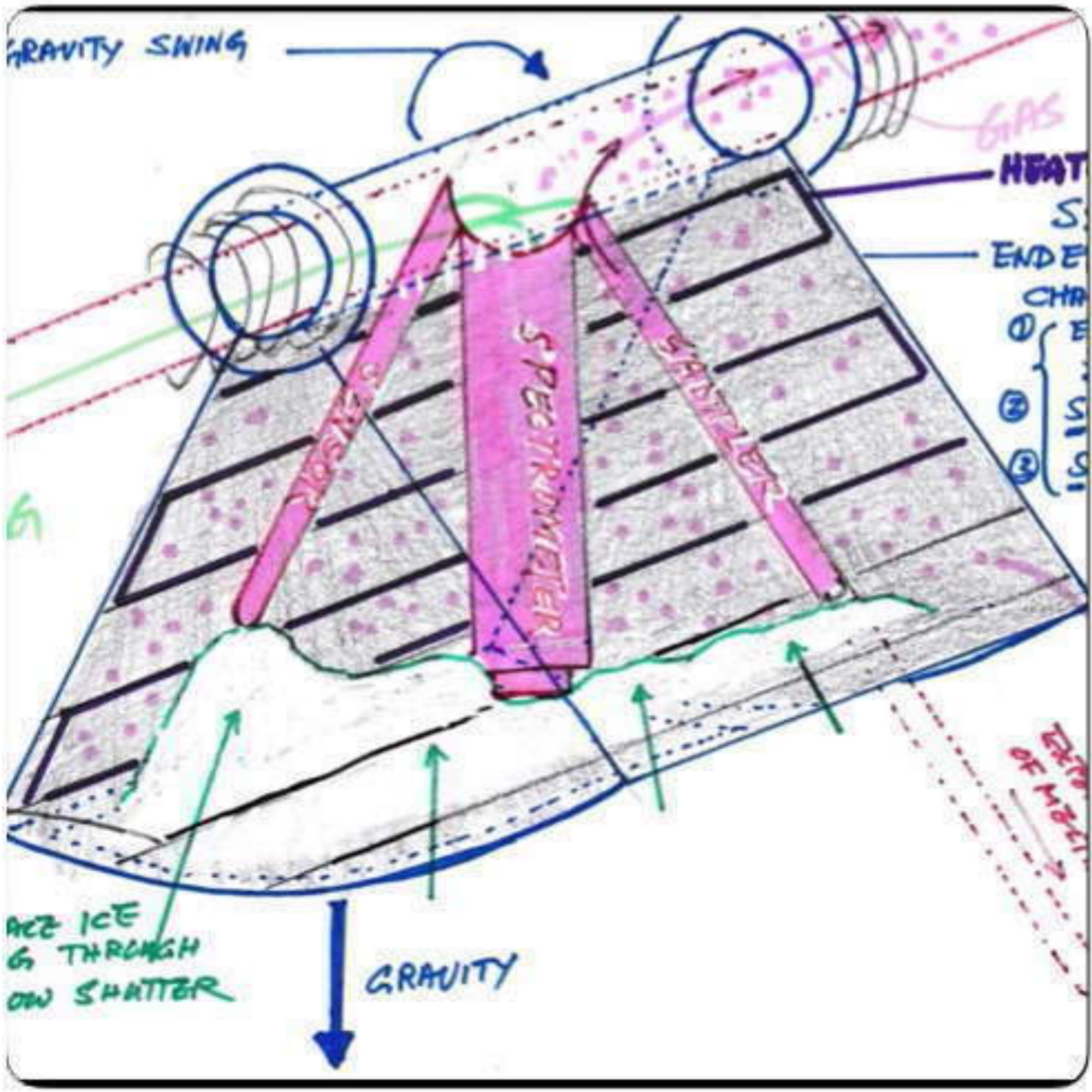
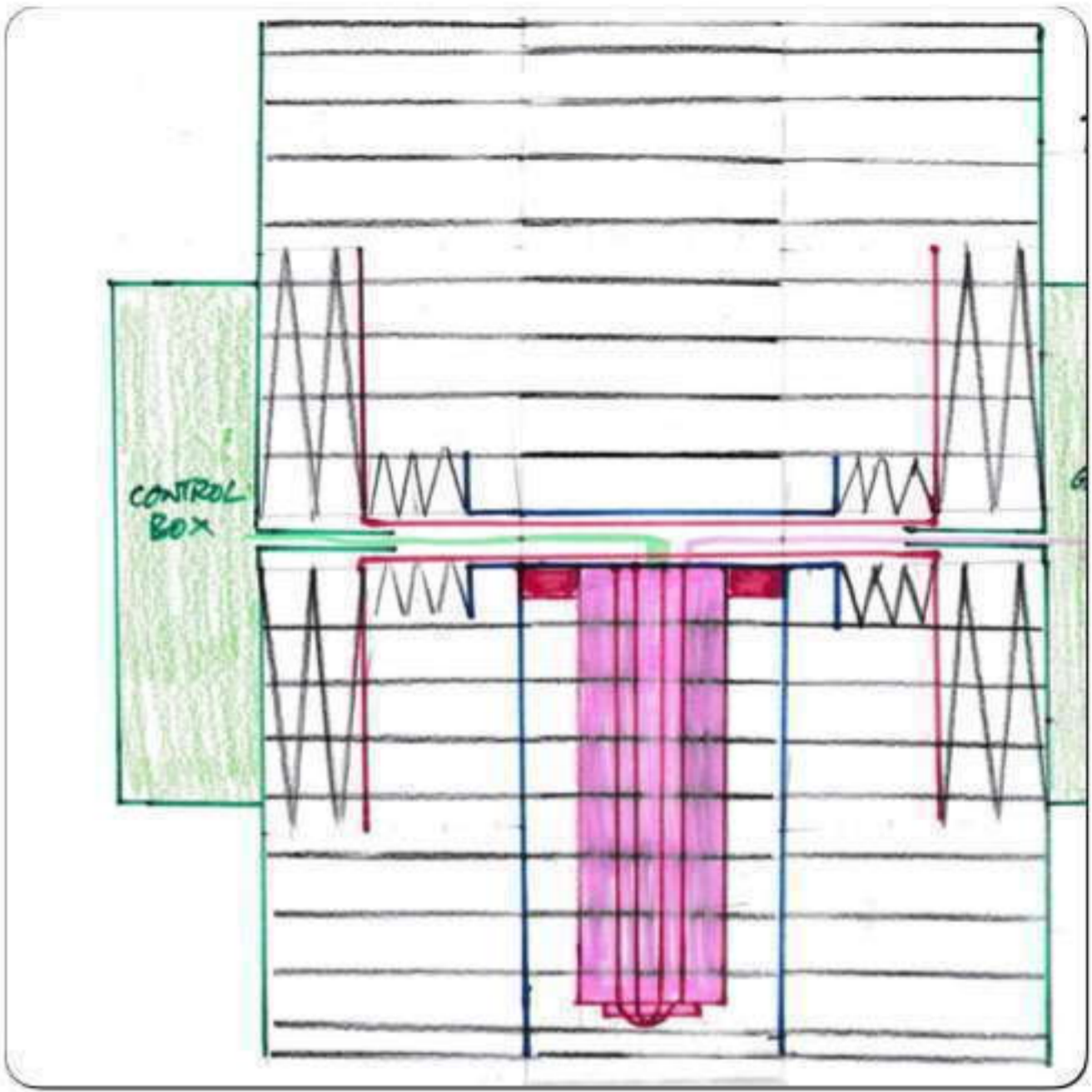
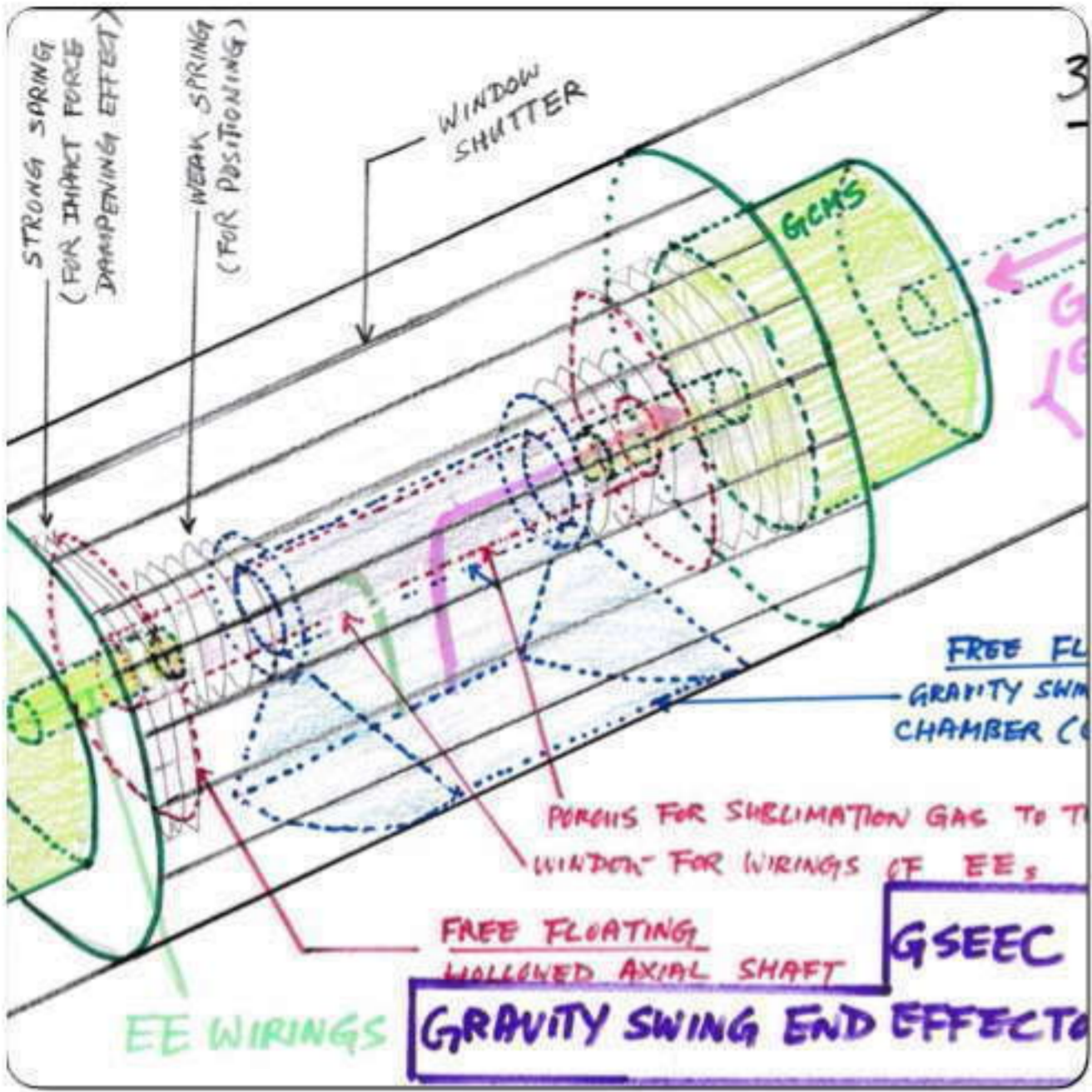

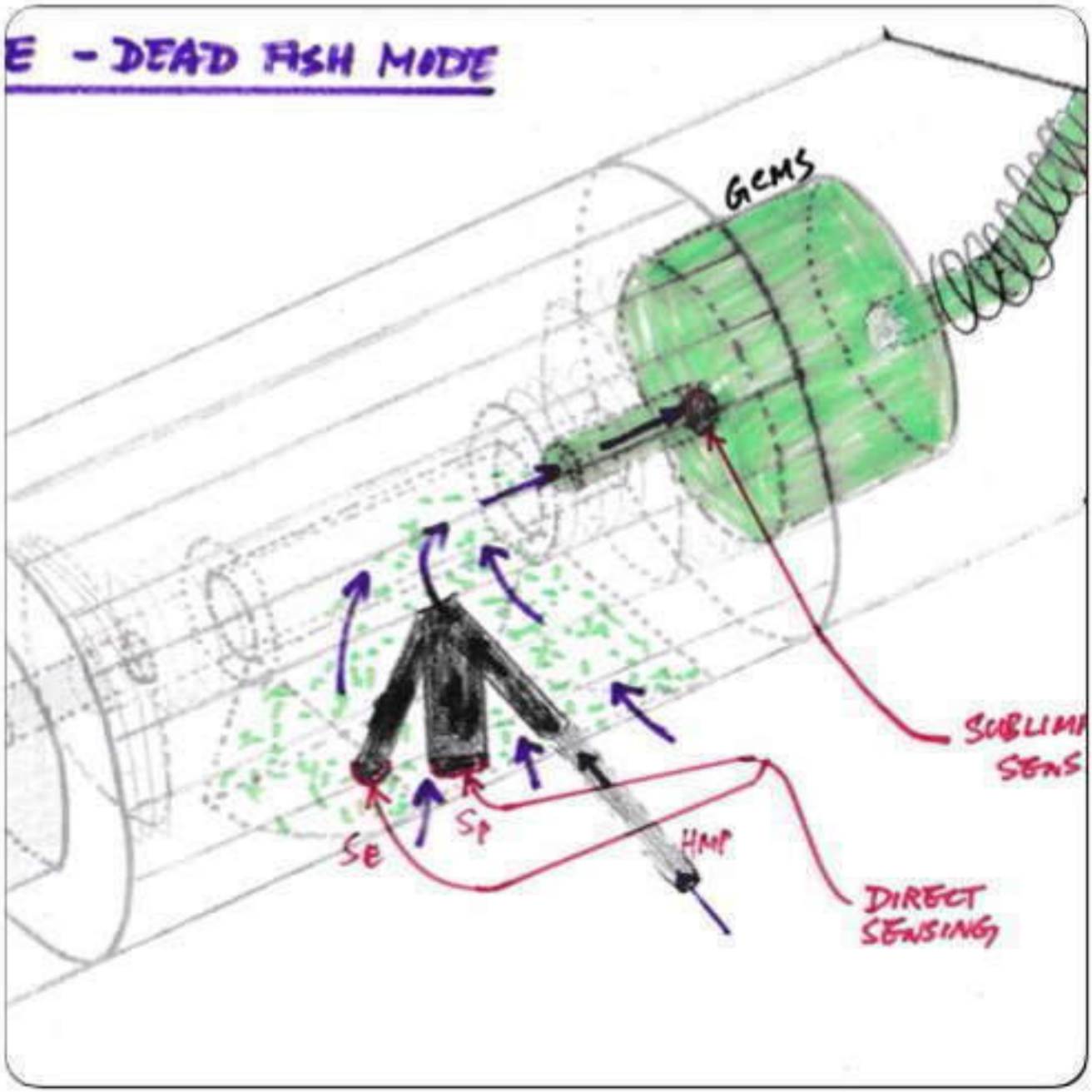
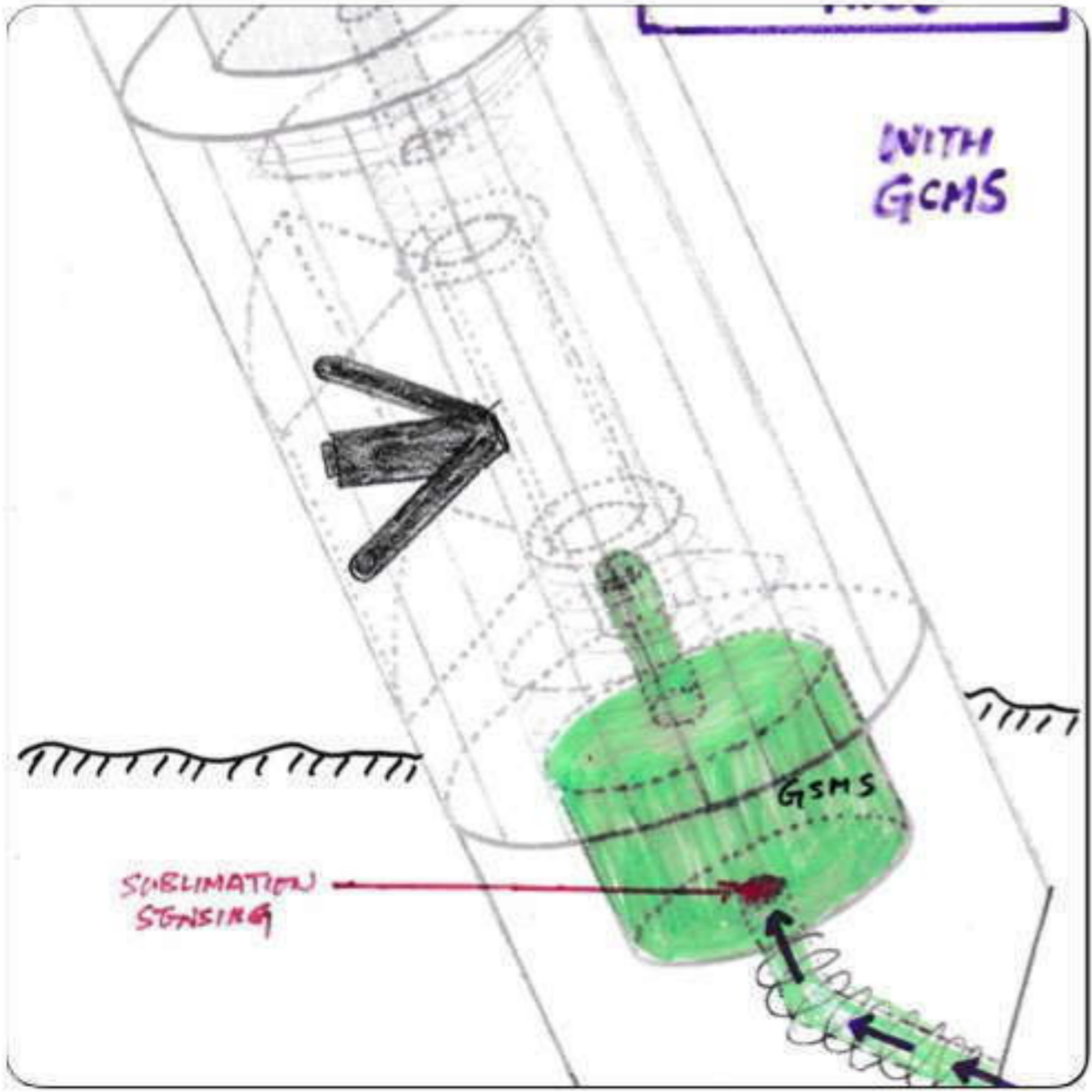
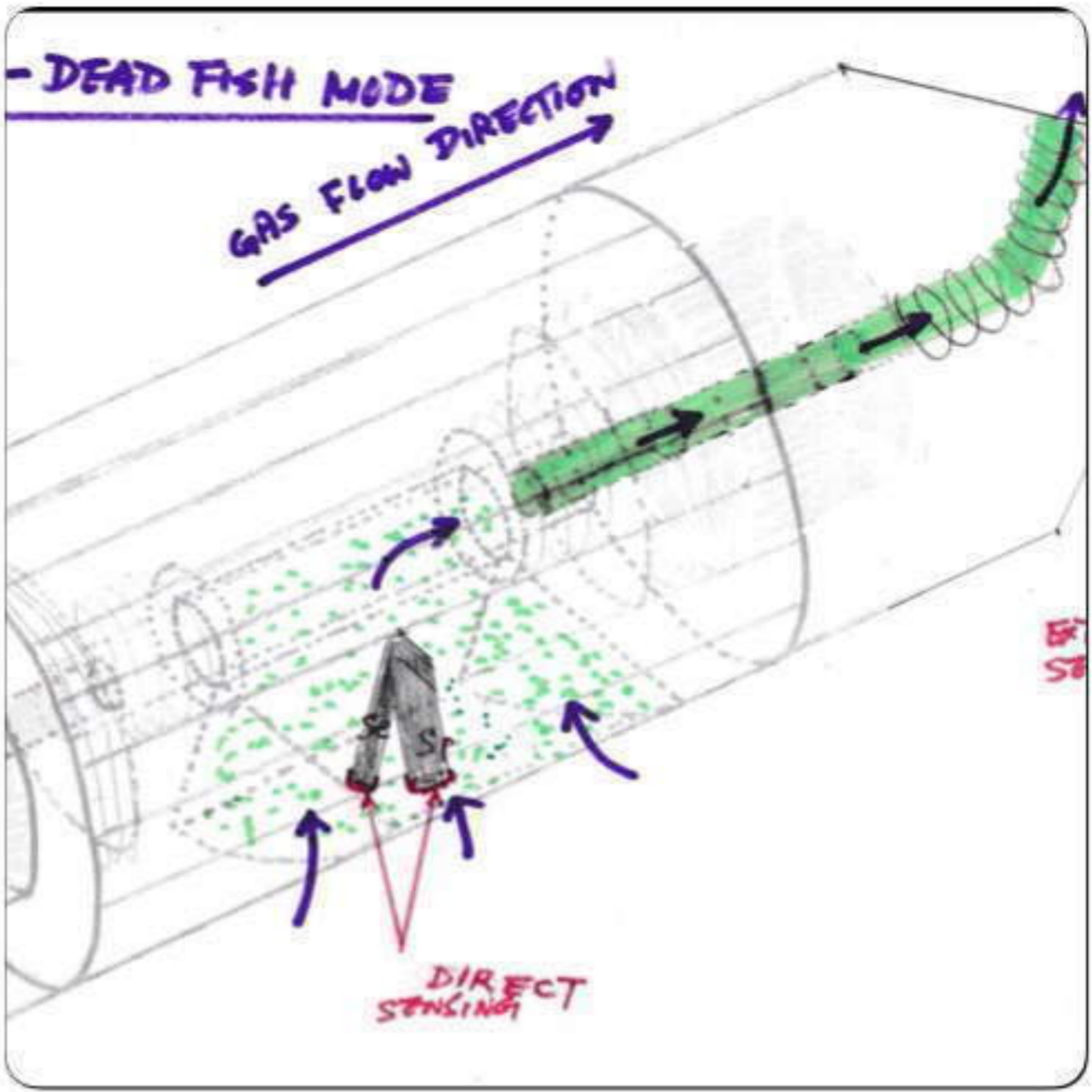
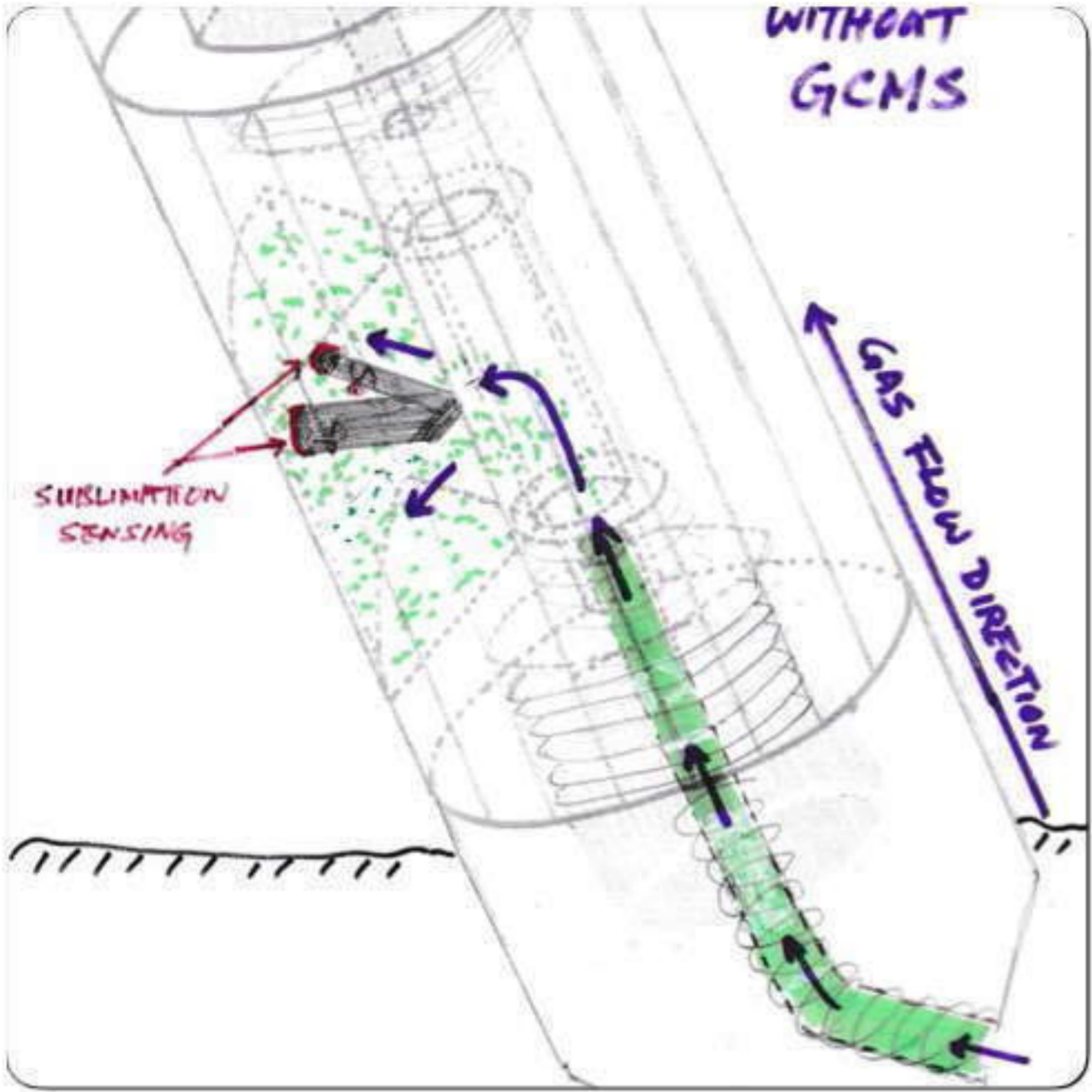

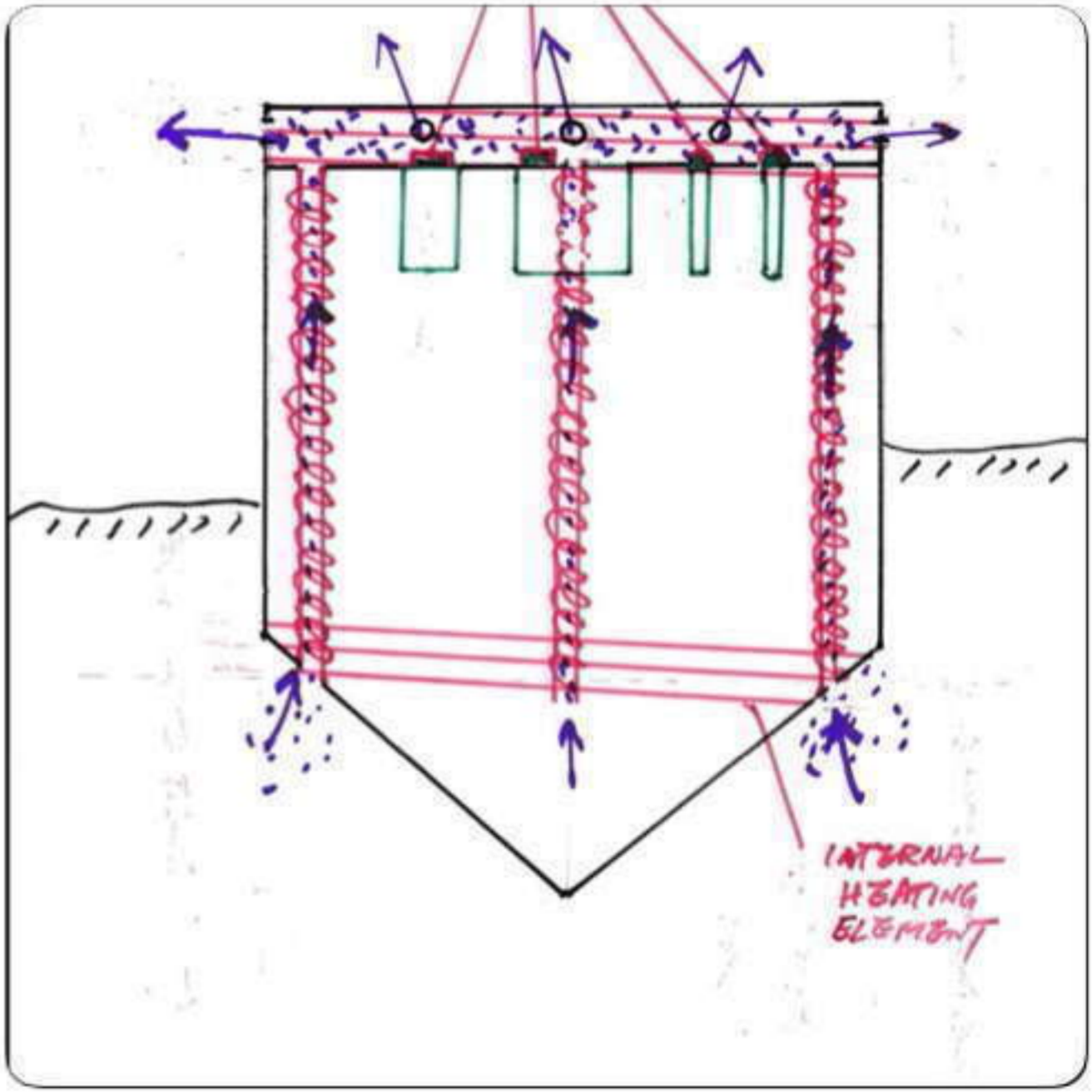
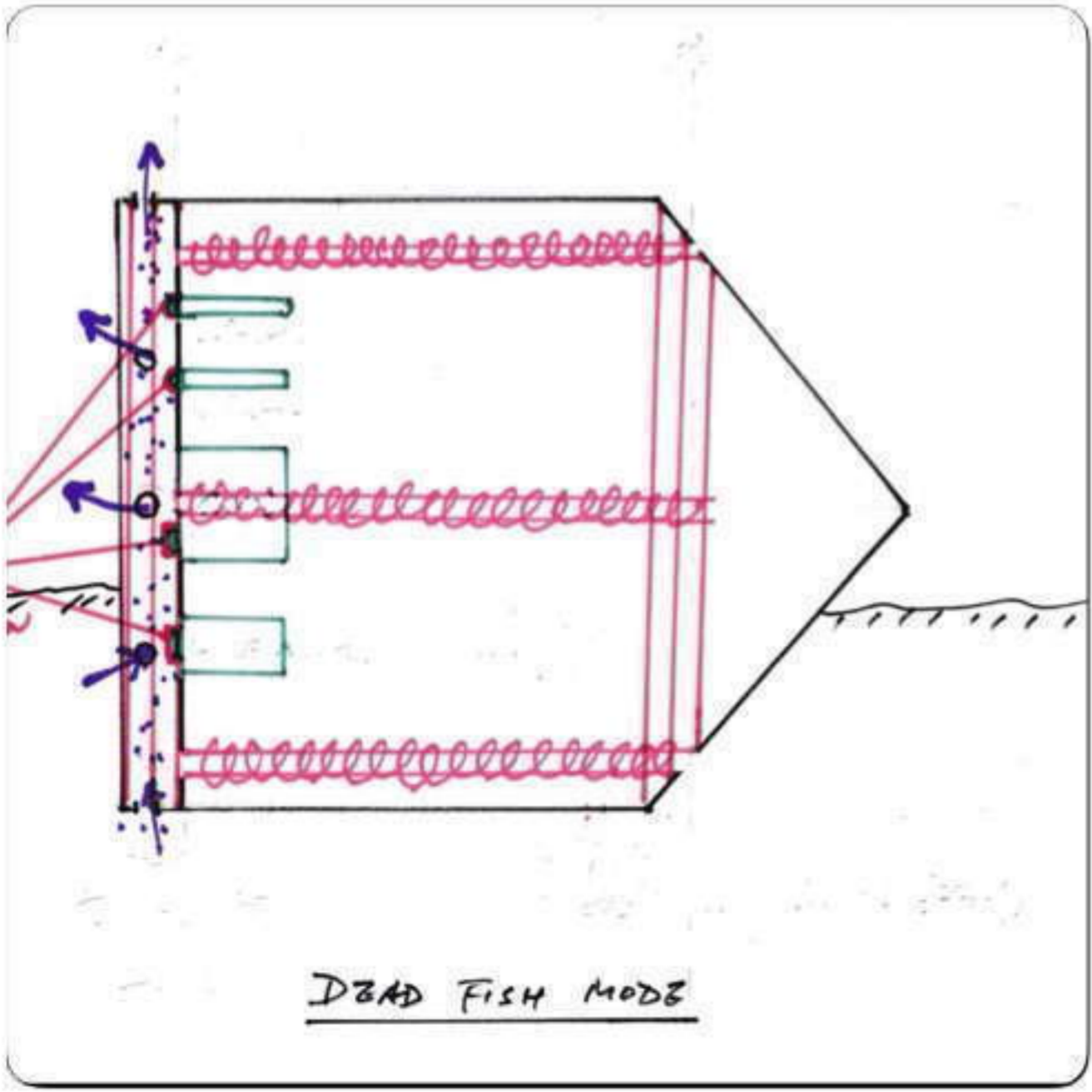
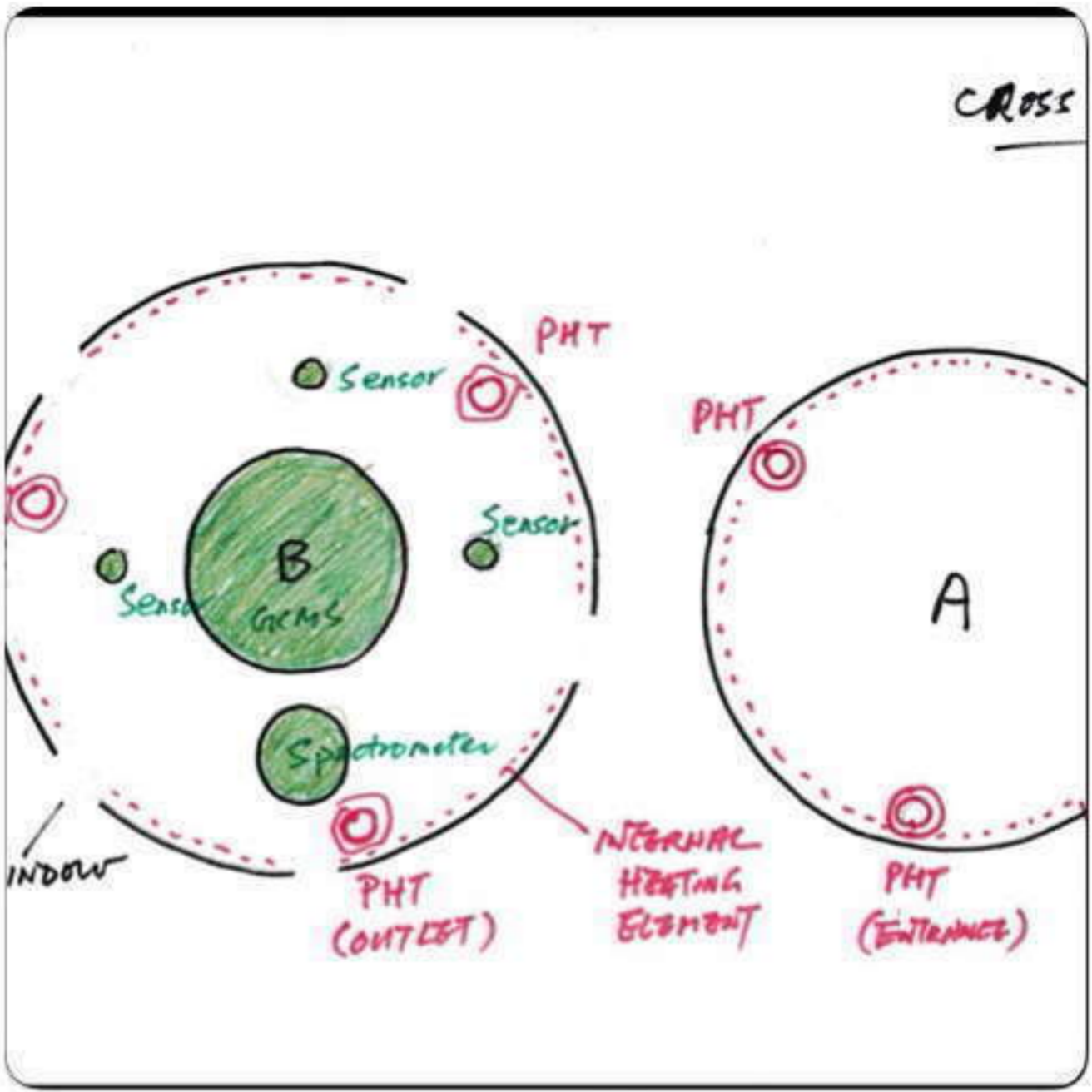
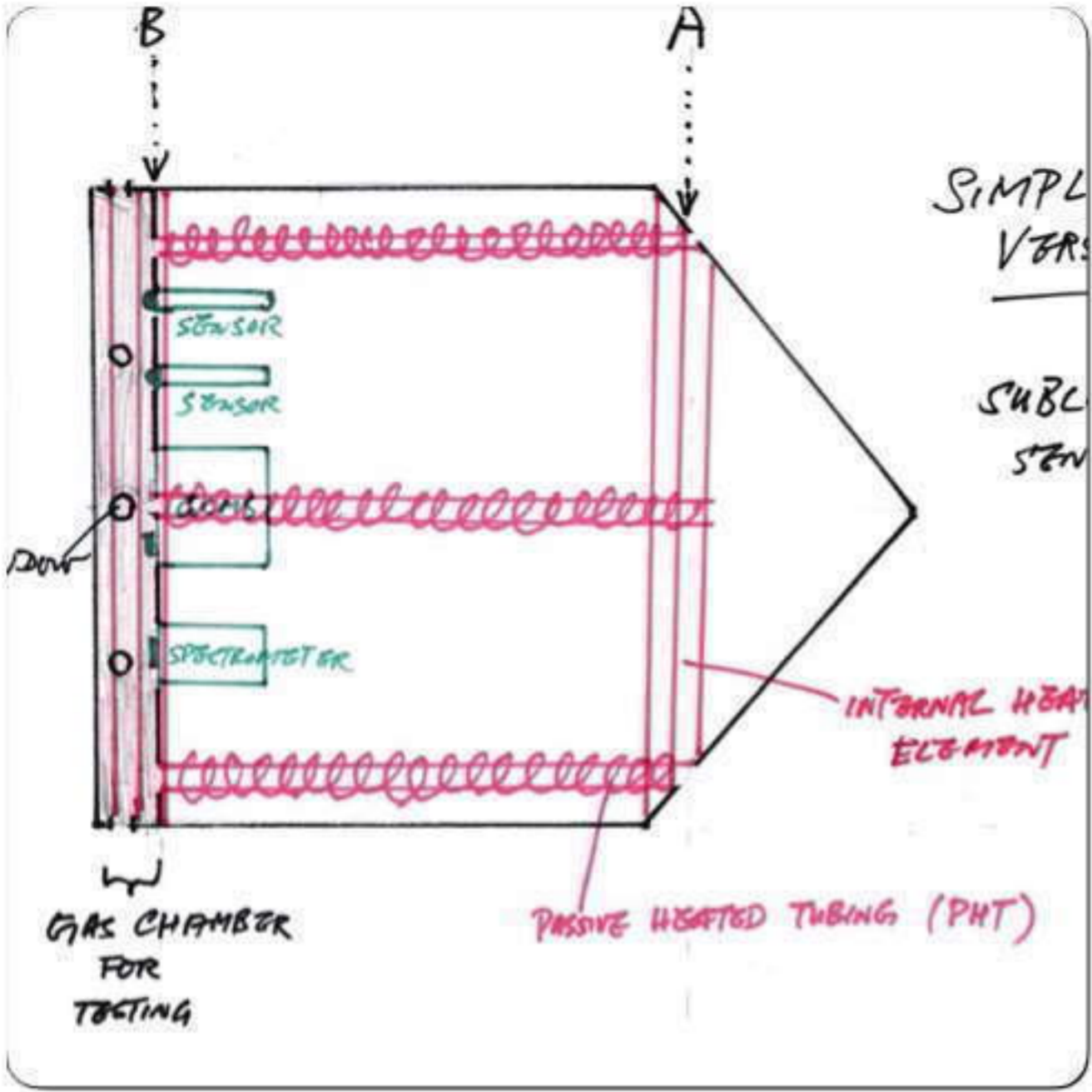

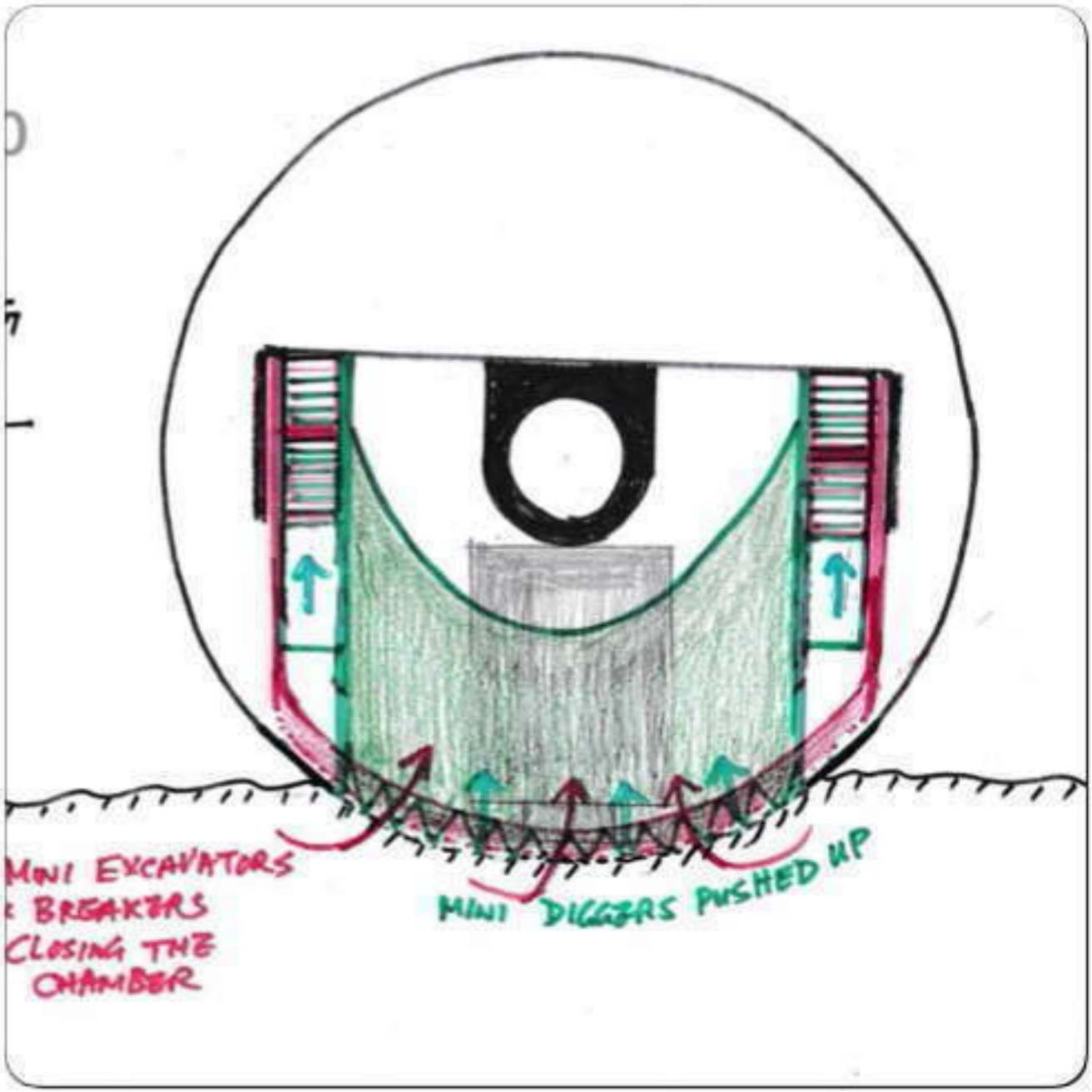
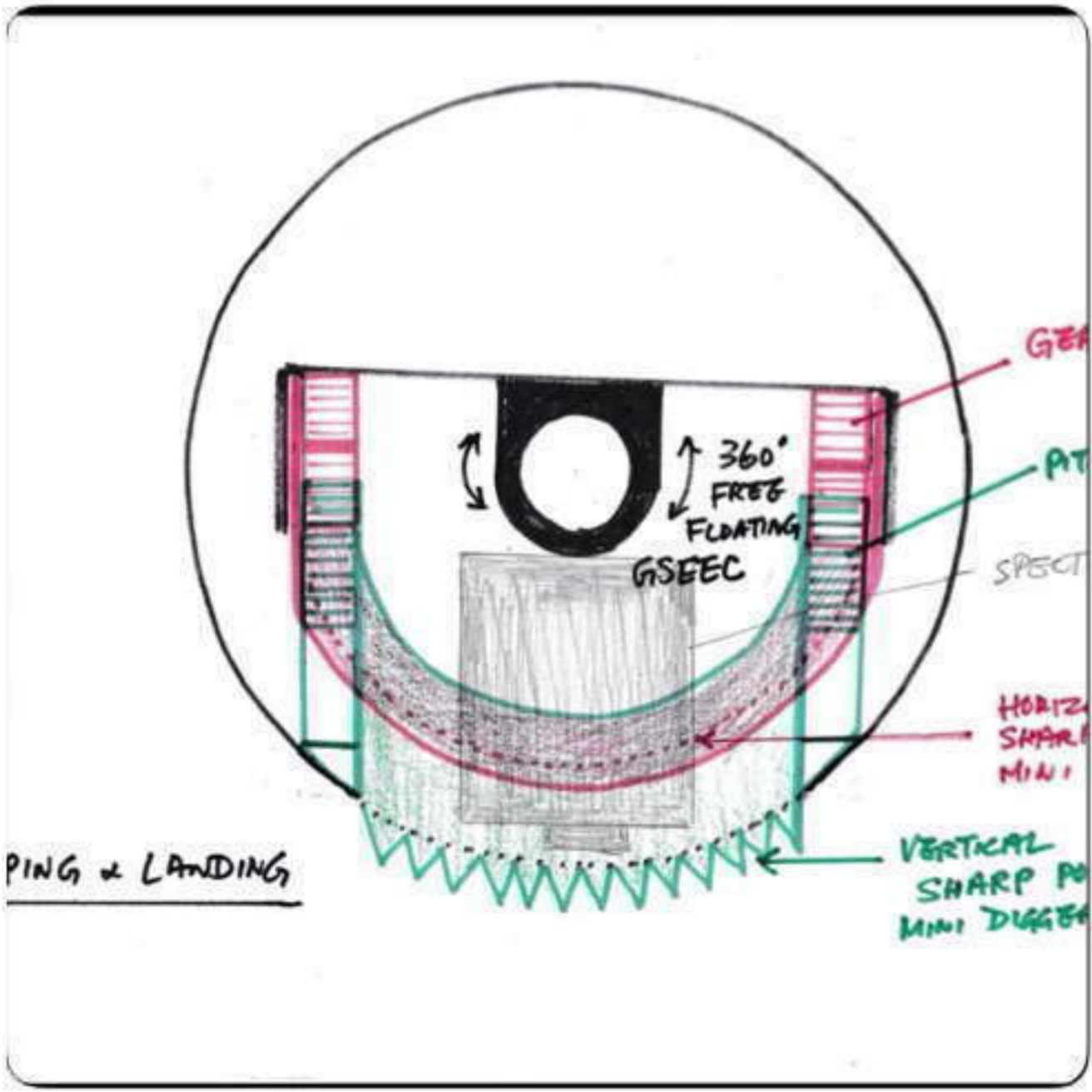
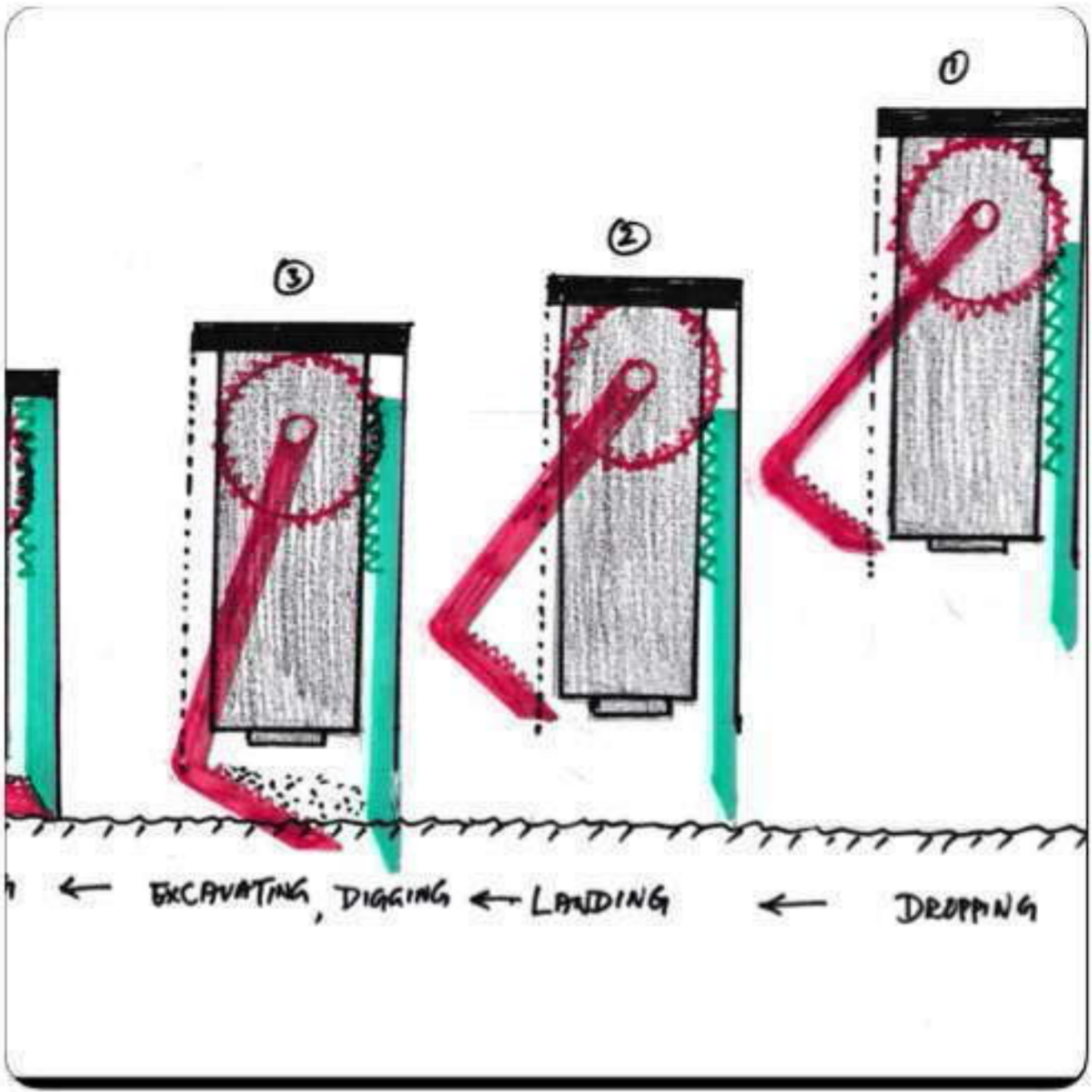
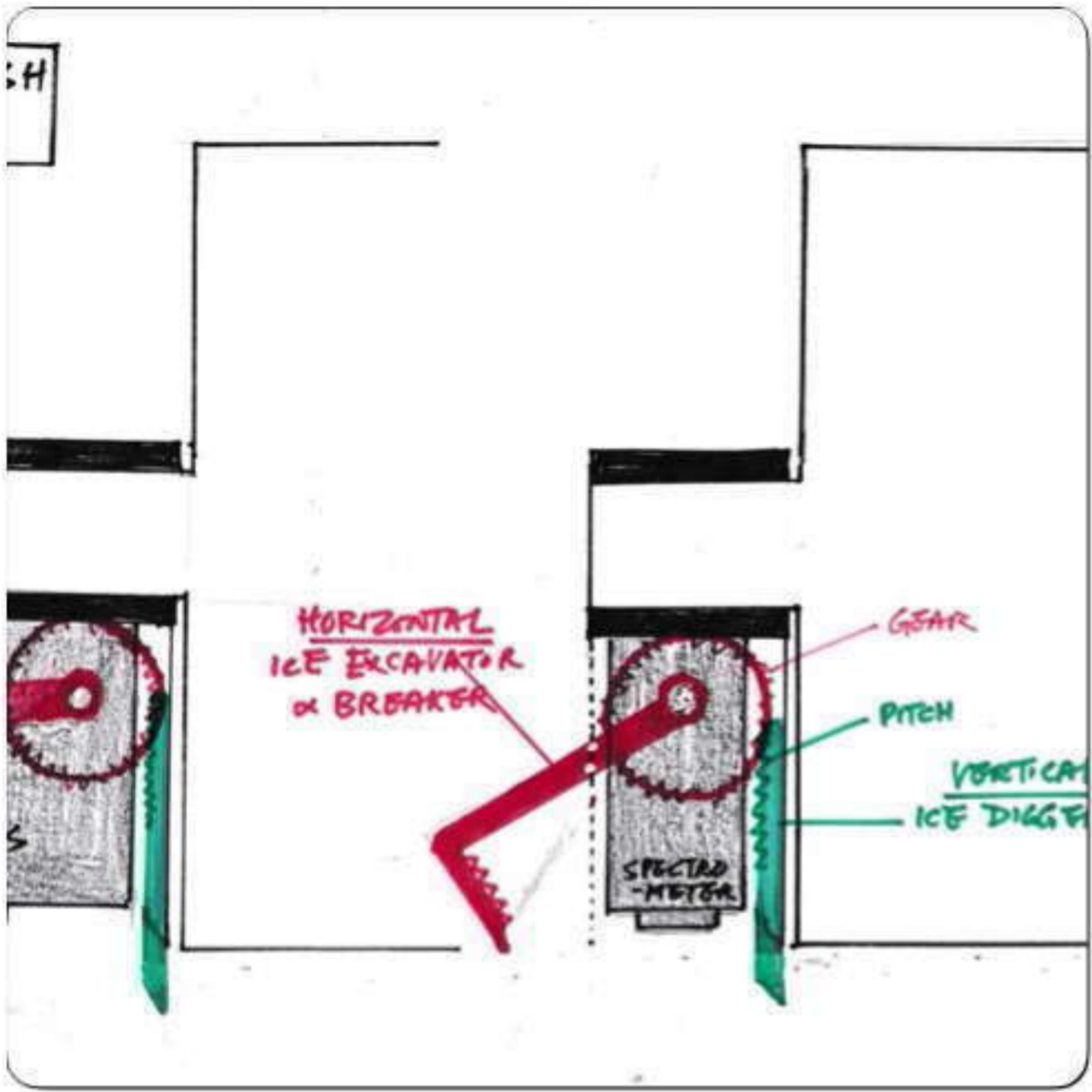

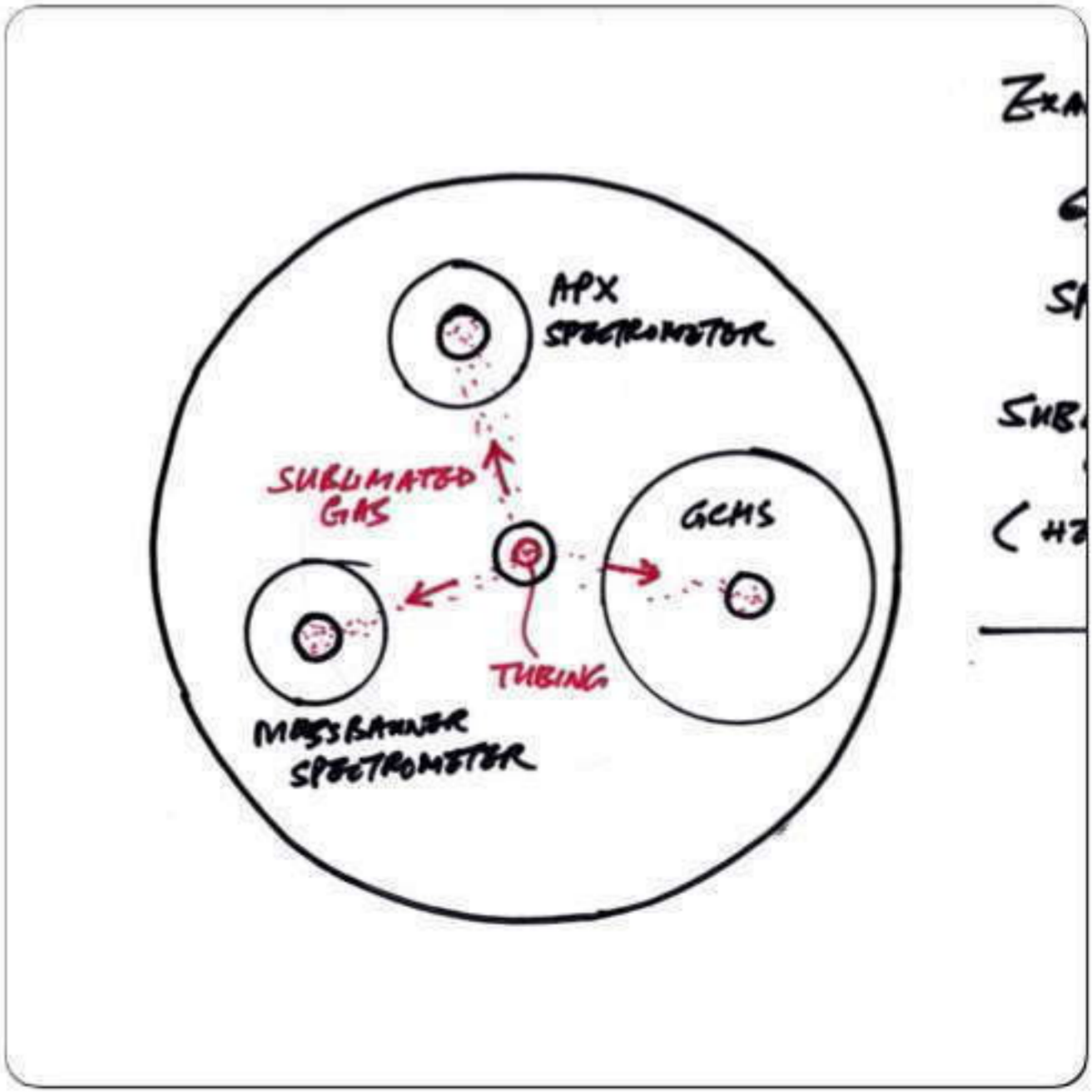
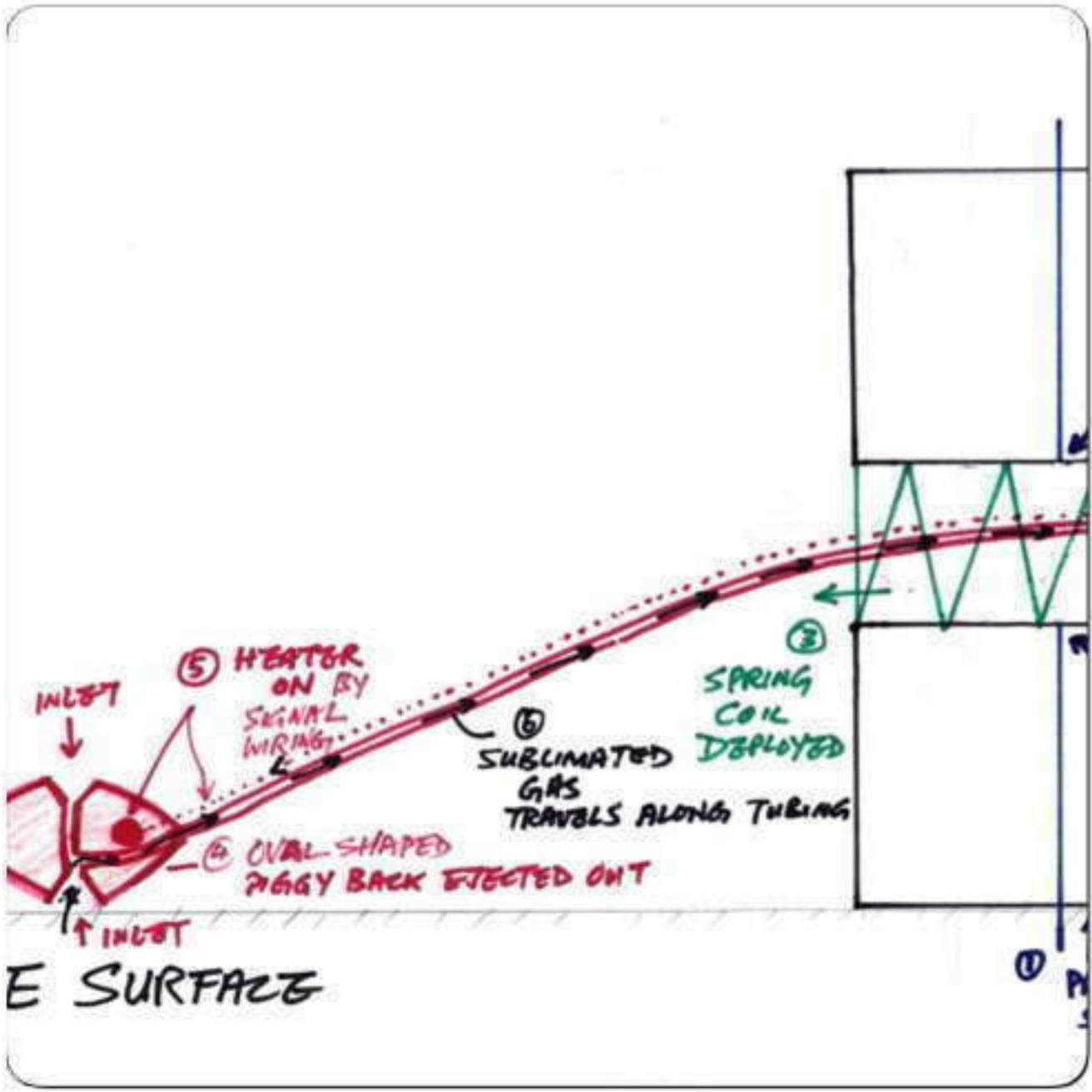
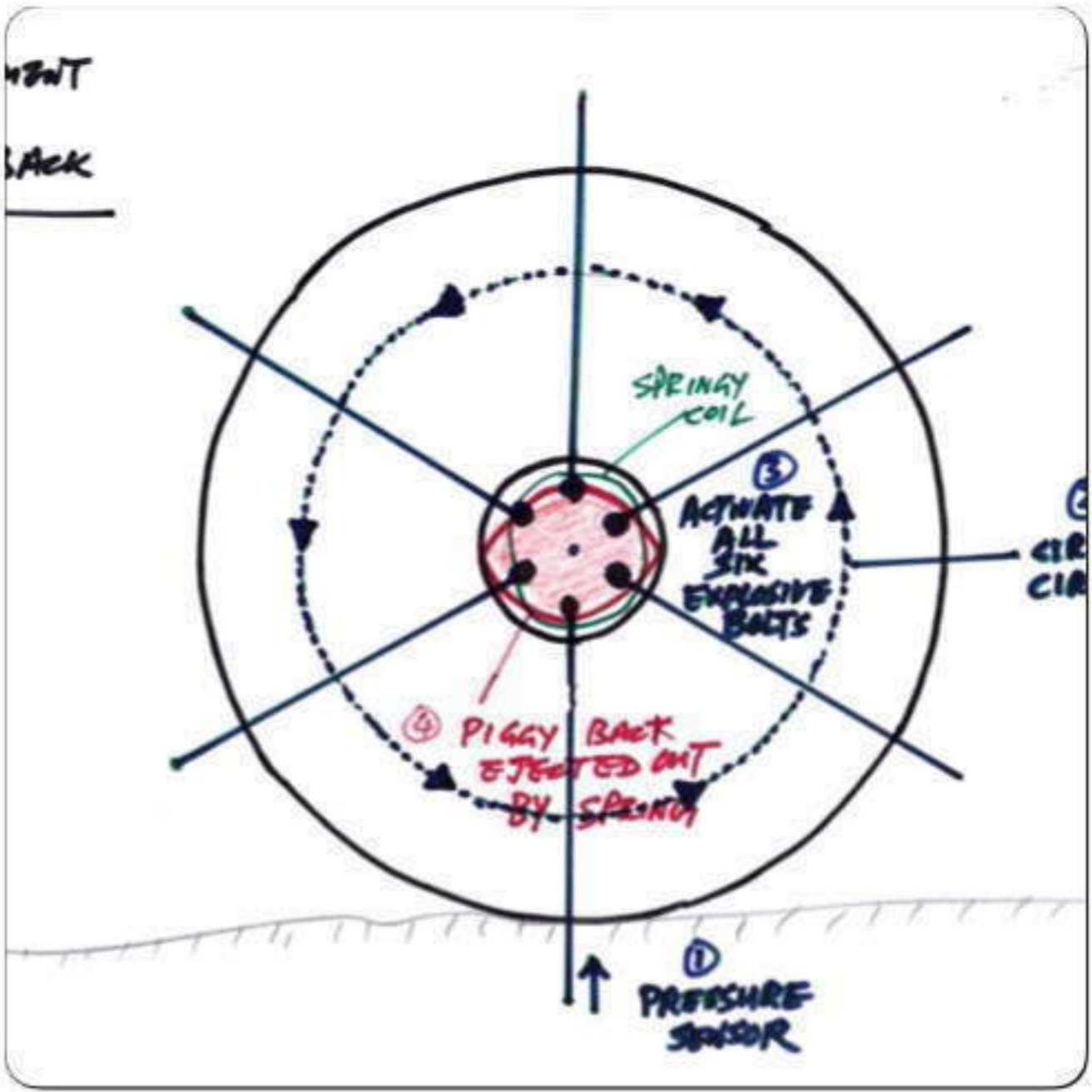
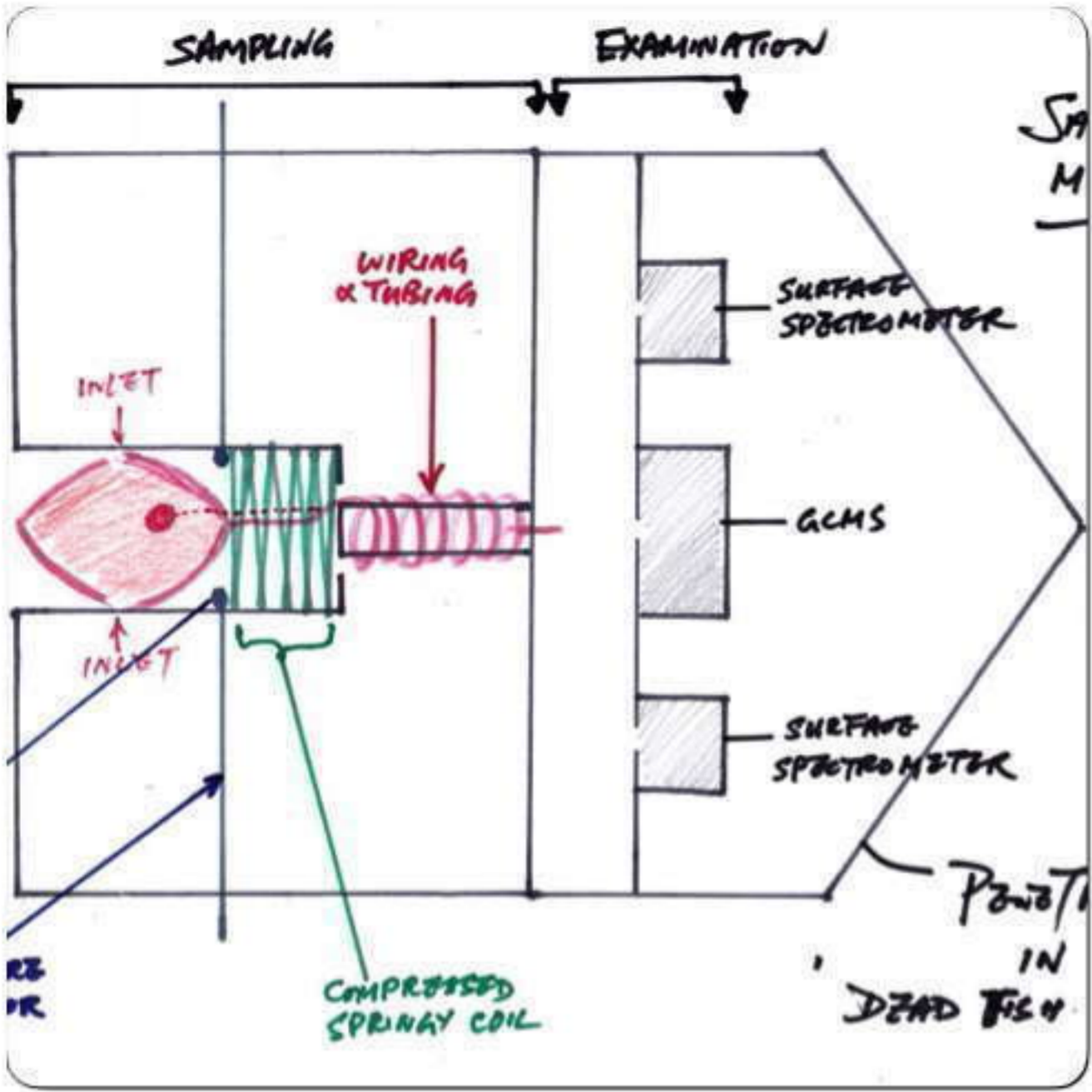

PIGGY BACK

7 LANDER + 3 MINI LANDER WITH RETRO ROCKET

